

Precision Rolling Bearings









Table of Contents

Technical Description

1 Bearing Selection		5 Preload and Rigidity	
1-1 Bearing Selection Procedure.....	2	5-1 Preload Objectives	14
1-2 Examine Bearing Type	3	5-2 Preload Methods.....	14
2 Bearing Life		5-3 Measuring Preload.....	14
2-1 Basic Dynamic Load Rating and Rated Life.....	4	5-4 Preload Effect	15
2-2 Dynamic Equivalent Load.....	4	5-5 Standard Preload and Axial Rigidity	16
2-3 Angular Contact Ball Bearing Load	5	6 Lubrication	
2-4 Basic Static Load Rating and Static Equivalent Load.....	6	6-1 Purpose of Lubrication	22
3 Bearing Tolerance		6-2 Lubrication Methods.....	22
3-1 Radial Bearing Tolerances.....	7	7 Limiting Speeds	
3-2 Tolerances and Permissible Values of Angular Contact Ball Bearings for Thrust Loads (TAH/TBH Series)	9	7-1 Limiting Speed Correction	26
3-3 Tolerances of Cross Tapered Roller Bearings	9	8 Shaft and Housing Design	
3-4 Ball Screw Support Bearing (TAB Series) Tolerances	10	8-1 Shaft and Housing Fit	27
3-5 Tolerances for Ball Screw Support Bearing (TAF Series)	11	8-2 Recommended Accuracy for Shaft and Housing	28
3-6 Tolerances for Tapered Bores (Cylindrical Roller Bearings)	11	8-3 Chamfer Dimension Limits.....	29
4 Bearing Arrangement		9 Bearing Handling	
4-1 Duplex Bearing Features	12	9-1 Storing and Transporting Bearings.....	30
4-2 Mounting and Mounting Symbols	13	9-2 Assembling Bearings.....	30
4-3 Flush Ground Angular Contact Ball Bearings	13	9-3 Running Test.....	34
		9-4 Removing Bearings	34

Dimension Tables

Precision Rolling Bearing Types and Designs	37
 Angular Contact Ball Bearings Standard Type	38
7900C/7900AC Series	40
7000C/7000AC Series	42
7200C/7200AC Series	44
 High-speed Angular Contact Ball Bearings	46
BNH Series	48
 Thrust Load Angular Contact Ball Bearings	50
TAH Series.....	52
TBH Series	54
 Multiple-row Cylindrical Roller Bearings	56
NN3000 Series	58
NNU4900 Series	60
 Cross Tapered Roller Bearings	62
XRN Series	64
XRG Series	66
 Ball Screw Support Bearings	68
TAB Series.....	70
TAF Series	72

Technical Description

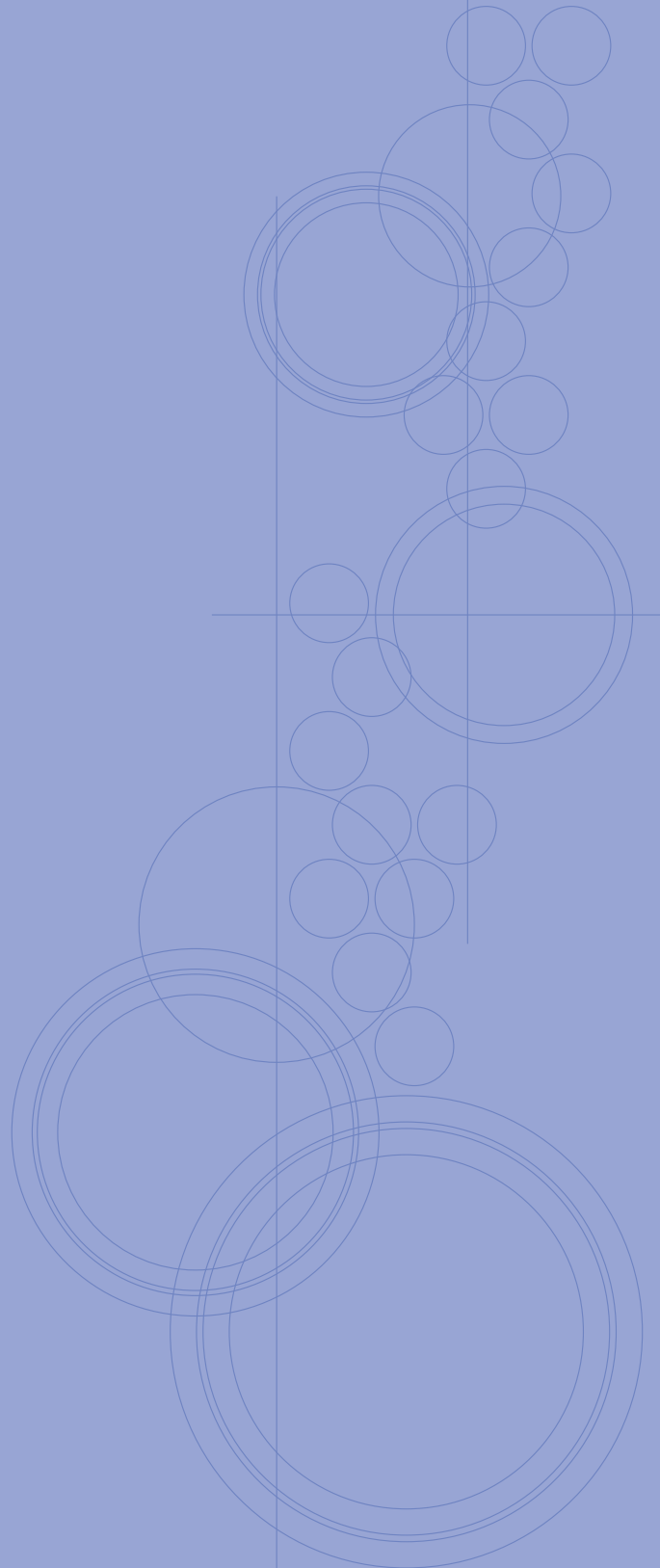

Technical Description

Bearing Selection

Bearing Life

Bearing Tolerance

Bearing Arrangement

Preload and Rigidity

Lubrication

Limiting Speeds

Shaft and Housing Design

Bearing Handling

1

Bearing Selection

1-1 Bearing Selection Procedure

While it is not easy to select the optimum bearing type and combination, it is no exaggeration to say that bearing selection is essential in order to obtain the desired design performance and service life. While there is no “best” procedure for selecting the optimal bearing,

the designer should consider giving priority to meeting the most critical requirement of the bearing. **Figure 1.1** provides an example of a procedure based on the establishment of priorities for the required bearing characteristics.

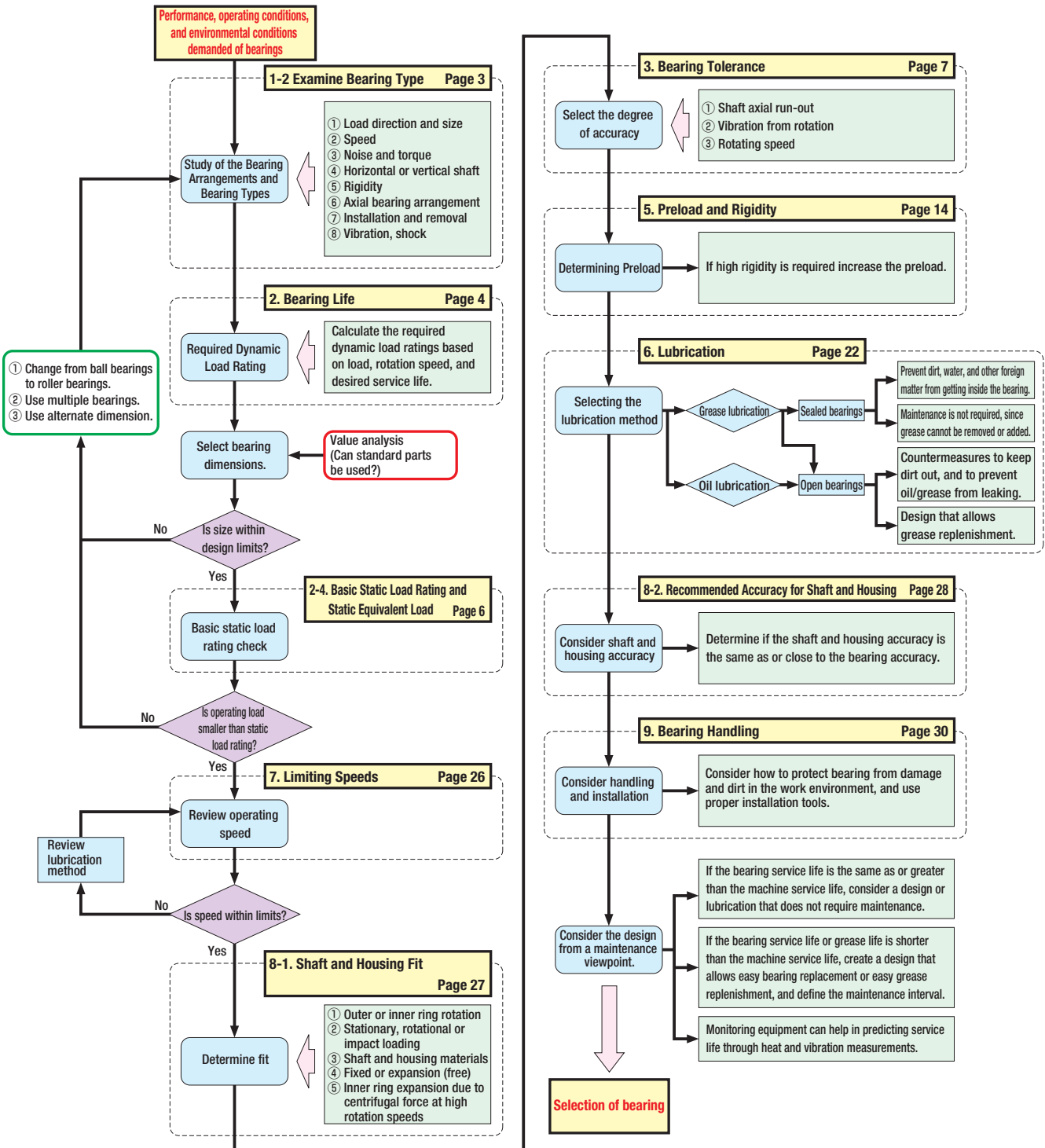

● **Figure 1.1** Bearing Selection Procedure

1-2 Examine Bearing Type

Factors	Selection guidelines
Allowable space for bearings	<ul style="list-style-type: none"> When designing a shaft system, the rigidity and strength of the shaft are important factors. The first step is to determine the shaft diameter, and the bore diameter. Figure 1.2 shows guidelines for the main precision rolling contact bearings types and sizes used in machine tools.
Load (type, direction, magnitude)	<ul style="list-style-type: none"> Select the optimum bearing type in accordance with the magnitude of radial and axial load, direction of the load (either one or both directions), and level (vibration or shock). In general, a roller bearing has a greater load rating capacity than a ball bearing.
Rotating speed	<ul style="list-style-type: none"> Select the bearing type in accordance with the maximum rotating speed specified for the machine where the bearing is used. The limiting speeds of bearings is largely depended on the magnitude of the load applied, running accuracy, cage material, and cage design. Therefore, careful consideration is necessary. In general, angular contact ball bearings or cylindrical roller bearings, which demonstrate minimal temperature rise, are used in high-speed applications.
Rigidity	<ul style="list-style-type: none"> In order to improve the rigidity of rotational axis, the rigidity of the shaft and housing, as well as the bearing rigidity become important. In general, roller bearing rigidity is greater than a ball bearing. The rigidity of combination angular contact ball bearing is increased by applying a preload to the bearing.
Mounting and dismounting	<ul style="list-style-type: none"> Selecting a separable bearing increases work efficiency during mounting and dismounting for periodic inspection, etc.

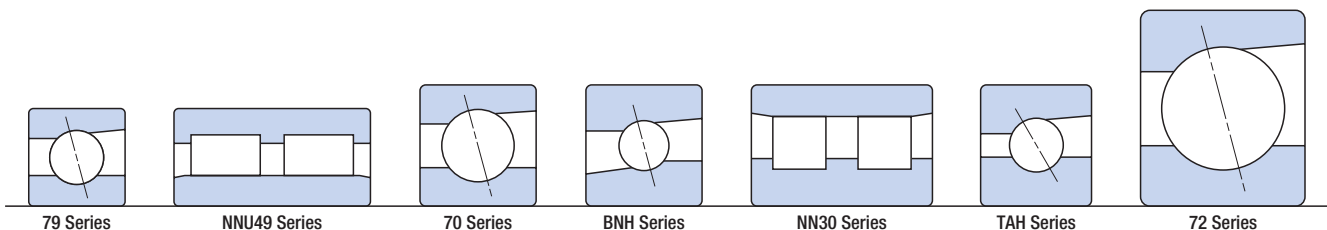

● Figure 1.2 Main Precision Rolling Bearings Used in Machine Tools



Bearing Life

2-1 Basic Dynamic Load Rating and Rated Life

Although the requirements of rolling contact bearings vary somewhat with the individual application, the principal requirements are:

- High load capabilities
- Low friction
- Smooth and quiet rotation
- High accuracy
- High rigidity

The reliability or durability requirement sets the time frame over which all other requirements are to be maintained. The reliability requirement (life in the broad sense) includes grease and acoustic life, as well as fatigue life. Reliability is reduced by various type of damage and degradation.

Though there are other damage such as breakage and seizure, these are considered to be separate from bearing life. Improper handling, mounting, lubrication, and fits are the major causes of problems leading to lower-than-calculated bearing life.

Regardless of how well they are maintained or mounted or handled, dynamic bearings will eventually fail from rolling fatigue generated by the repetitive stress of bearing load. The service life of a bearing can be examined from two perspectives: 1) If, from inspection, a trace of fatigue becomes noticeable, the bearing should be deemed not suitable for further use; or 2) length of bearing life in hours or revolutions can be predefined as a limit beyond which the bearing is automatically replaced. Since calculated fatigue life will vary with the size and type of bearings used under identical load conditions, great care must be taken in the analysis of the load conditions and the final choice of bearings to satisfy the application requirements.

Fatigue lives of individual bearing are dispersed. When a group of identical bearings operates under the same conditions, the statistical phenomenon of dispersion will appear. Use of average life is not an adequate criterion for selecting rolling contact bearings. Instead, it is more appropriate to consider the limit (hours or numbers of revolutions) which a large percentage of the operating bearings can attain.

Accordingly, the rating life and basic dynamic load rating Cr or Ca are defined using the following definition:

● Basic Rating Life

Total number of revolutions that 90% of a group of identical bearings operated individually under equal conditions can complete without suffering material damage from rolling fatigue.

● Basic Dynamic Load Rating (Cr or Ca)

Bearing load of constant direction and magnitude that ends the bearing life after one million revolutions.

The rating life of bearings is calculated by **Formula 2.1** and **Formula 2.2**.

$$L = \left(\frac{C}{P} \right)^p \text{ ————— (Formula 2.1)}$$

$$L_h = \left(\frac{C}{P} \right)^p \cdot \frac{10^6}{60n} \text{ ————— (Formula 2.2)}$$

- L : Basic rating life (10⁶ revolutions)
- L_h : Basic rating life (hours)
- C : Basic Dynamic Load Rating (N) (Cr for radial bearings, Ca for thrust bearings)
- P : Bearing Load (Dynamic Equivalent Load) (N) (Pr for radial bearings, Pa for thrust bearings)
- p : 3 (ball bearings), 10/3 (roller bearings)
- N : RPM: (min⁻¹)

In the case of multiple rows of radial ball bearing arrangements, the basic dynamic load rating is calculated using the factors provided below.

2-row arrangement	3-row arrangement	4-row arrangement
1.62	2.16	2.64

2-2 Dynamic Equivalent Load

Bearing load P in Formula 2.1 and Formula 2.2 is the pure radial load (pure axial load) of constant direction and magnitude. Under actual operating conditions, there are many cases where radial and axial loads are applied simultaneously. In such cases, bearing life must be calculated by converting the radial and axial loads into dynamic equivalent load.

Dynamic equivalent load is calculated using **Formula 2.3**.

Bearing load of constant direction and magnitude that ends the bearing life after one million revolutions.

The rating life of bearings is calculated by Formula 2.1 and Formula 2.2.

$$Pr = XFr + YFa \text{ or } Pa = XFr + YFa \text{ — (Formula 2.3)}$$

- Pr : Dynamic equivalent radial load (N)
- Pa : Dynamic equivalent axial load (N)
- Fr : Radial load (N)
- Fa : Axial load (N)
- X : Radial load factors (Table 2.1)
- Y : Axial load factors (Table 2.1)

● Table 2.1 Load Factors

	Nominal contact angle	iFa/Cor	e	Single-row/single-direction bearing		Multiple-row/multiple-direction bearing						
				Fa/Fr > e		Fa/Fr ≤ e		Fa/Fr > e				
				X	Y	X	Y	X	Y			
Radial ball bearings	15°	0.015	0.38	0.44	1.47	1	1.65	0.72	2.39			
		0.029	0.40							1.40	1.57	2.28
		0.058	0.43							1.30	1.46	2.11
		0.087	0.46							1.23	1.38	2.00
		0.12	0.47							1.19	1.34	1.93
		0.17	0.50							1.12	1.26	1.82
		0.29	0.55							1.02	1.14	1.66
		0.44	0.56							1.00	1.12	1.63
		0.58	0.56							1.00	1.12	1.63
		25°	—							0.68	0.41	0.87
30°	—	0.80	0.39	0.76	0.78	0.63	1.24					
40°	—	1.14	0.35	0.57	0.55	0.57	0.93					
50°	—	1.49	0.73	1	1.37	0.57	0.73	1				
Thrust ball bearings	55°	—	1.79	0.81	1	1.6	0.56	0.81	1			
	60°	—	2.17	0.92	1	1.9	0.55	0.92	1			

- Note 1) i = 2 for DB or DF, i = 1 for Single or DT.
- Note 2) For Single or DT, use Pr=Fr when Fa/Fr ≤ e.
- Note 3) When the nominal contact angle is 15°, use linear interpolation to determine X, Y, and e values of iFa/Cor that are not included in the table.
- Note 4) For high-speed use (dmn value > 800,000), the centrifugal force of the roller must also be taken into consideration in addition to the external load. Please consult NACHI concerning such applications.

2-3 Angular Contact Ball Bearing Load

In the case of angular contact ball bearings, the points where the extended contact lines within the bearing and the axis as shown in **Figure 2.1** must be used as the bearing support points (load centers).

Because of this, angular contact ball bearings are shown in dimension tables with "a" dimensions indicating support point positions. This consideration is particularly important when a moment load is acting on a bearing series.

Axial component forces are generated when a radial load acts on an angular contact ball bearing. You can calculate the axial component forces using **Formula 2.4**.

$$Fa' = \frac{Fr}{2Y} \quad \text{(Formula 2.4)}$$

Fa' : Induced axial load (N)
Fr : Radial load (N)
Y : Axial load factor

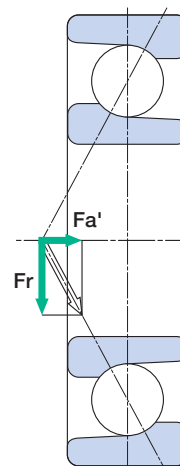

● **Figure 2.1** Induced Axial Load for Angular Contact Ball Bearings

Due to these component forces, the axial load and dynamic equivalent radial load acting on the bearing is as shown in **Table 2.2**.

● **Table 2.2** Axial Load and Dynamic Equivalent Load of Angular Contact Ball Bearings

Bearing arrangement	Load conditions	Axial load	Dynamic equivalent radial load
	$Fa \geq 0.5 \left(\frac{Fr_I}{Y_I} - \frac{Fr_{II}}{Y_{II}} \right)$	$F_{aI} = F_{aII} + Fa$ $F_{aII} = 0.5 \frac{Fr_{II}}{Y_{II}}$	$Pr_I = X_I Fr_I + Y_I (F_{aII} + Fa)$ $Pr_{II} = Fr_{II}$
	$Fa < 0.5 \left(\frac{Fr_I}{Y_I} - \frac{Fr_{II}}{Y_{II}} \right)$	$F_{aI} = 0.5 \frac{Fr_I}{Y_I}$ $F_{aII} = F_{aI} - Fa$	$Pr_I = Fr_I$ $Pr_{II} = X_{II} Fr_{II} + Y_{II} (F_{aI} - Fa)$
	$Fa \geq 0.5 \left(\frac{Fr_{II}}{Y_{II}} - \frac{Fr_I}{Y_I} \right)$	$F_{aI} = 0.5 \frac{Fr_I}{Y_I}$ $F_{aII} = F_{aI} + Fa$	$Pr_I = Fr_I$ $Pr_{II} = X_{II} Fr_{II} + Y_{II} (F_{aI} + Fa)$
	$Fa < 0.5 \left(\frac{Fr_{II}}{Y_{II}} - \frac{Fr_I}{Y_I} \right)$	$F_{aI} = F_{aII} - Fa$ $F_{aII} = 0.5 \frac{Fr_{II}}{Y_{II}}$	$Pr_I = X_I Fr_I + Y_I (F_{aII} - Fa)$ $Pr_{II} = Fr_{II}$

Fr_I, Fr_{II} : Radial load (N) applied to bearings I and II
 Y_I, Y_{II} : Axial load factors of bearings I and II
 Pr_I, Pr_{II} : Dynamic equivalent radial load (N) of bearings I and II
 Fa : External axial load (N)
 X_I, X_{II} : Radial load factors of bearings I and II

Bearing Selection

Bearing Life

Bearing Tolerance

Bearing Arrangement

Preload and Rigidity

Lubrication

Limiting Speeds

Shaft and Housing Design

Bearing Handling

Bearing Life

2-4 Basic Static Load Rating and Static Equivalent Load

2.4.1 Basic Static Load Rating

Load applied to stationary bearings can create permanent indentions in the load surfaces. While some level of deformation can be tolerated, a level of deformation will be reached where noise and vibration during operation of the bearing, will make the bearing unusable. The term Basic Static Load Rating (Cor or Coa) refers to the maximum contact stress value of the static load when the rolling element and raceways contact.

Ball bearings — 4200 MPa
Roller bearings — 4000 MPa

With these contact stresses, the sum of deformations is approximately 1/10,000 of the diameter of the rolling element. (Figure 2.2).

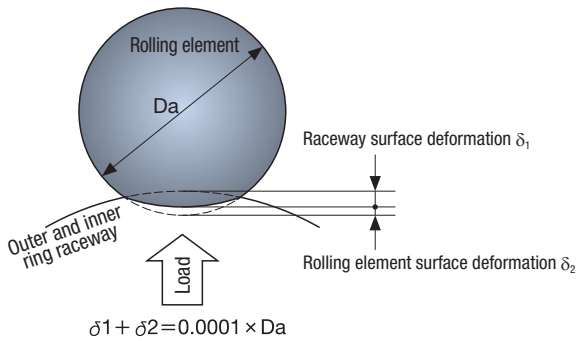

● Figure 2.2 Permanent Indentation

2.4.2 Static Equivalent Load

Static equivalent load is the static load that reflects the actual load conditions to the contact section of the rolling elements and raceway receiving the maximum stress.

For radial bearings, radial load of a constant direction and magnitude is called the static equivalent radial load, and for thrust bearings, axial load of a constant direction and magnitude is called the static equivalent axial load.

To calculate the static equivalent radial load, the larger of the two values obtained from Formula 2.5 and Formula 2.6 are to be used.

$$P_{or} = X_o F_r + Y_o F_a \quad \text{—————} \quad \text{(Formula 2.5)}$$

$$P_{or} = F_r \quad \text{—————} \quad \text{(Formula 2.6)}$$

The static equivalent axial load is calculated using Formula 2.7.

$$P_{oa} = X_o F_r + Y_o F_a \quad \text{—————} \quad \text{(Formula 2.7)}$$

- P_{or} : Static equivalent radial load (N)
- P_{oa} : Static equivalent axial load (N)
- F_r : Radial load (N)
- F_a : Axial load (N)
- X_o : Static radial load factors (Table 2.3)
- Y_o : Static axial load factors (Table 2.3)

● Table 2.3 Static Load Factors

	Nominal contact angle	Single or DT		DB or DF	
		X _o	Y _o	X _o	Y _o
Radial ball bearings	15°	0.5	0.46	1	0.92
	25°	0.5	0.38	1	0.76
	30°	0.5	0.33	1	0.66
	40°	0.5	0.26	1	0.52
Thrust ball bearings	50°	2.74	1	2.74	1
	55°	3.28	1	3.28	1
	60°	3.98	1	3.98	1

2.4.3 Safety Factors

The basic static load rating is considered as the limiting load for general applications.

An application may require a safety factor larger than 1.

Formula 2.8 and Table 2.4 show the calculation formula and safety factors (guidelines).

$$P_o \max = \frac{C_o}{S_o} \quad \text{—————} \quad \text{(Formula 2.8)}$$

- P_{o max} : Permissible static equivalent load (N)
- C_o : Basic static load rating (N)
- S_o : Safety factors (Table 2.4)

● Table 2.4 Safety Factors S_o

Application conditions	S _o	
	Ball bearings	Roller bearings
High rotating accuracy is needed	2	3
Vibration and or impact present	1.5	2
Normal operating conditions	1	1.5

2.4.4 Permissible Thrust Load

A permissible thrust load exists for bearings that can be applied with axial load like an angular contact ball bearings.

For ball bearings, the permissible load is the smaller of the following two values.

- ① Axial load when the contact pressure value between the roller and raceway surfaces is 4200 MPa or less
- ② Axial load causing the contact ellipse formed between the roller and raceway surface to deviate beyond the raceway shoulder (Figure 2.3)

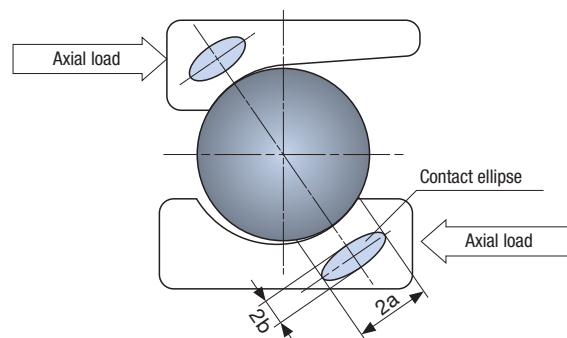

● Figure 2.3 Contact Ellipse



Bearing Tolerance

Technical Description

3-1 Radial Bearing Tolerances

The tolerance of rolling contact bearings includes dimensional and running accuracy. The tolerances is classified by ISO 492 and JIS B 1514 (Rolling bearings - Tolerances), with precision rolling bearings

conforming to Class 5, 4, and 2.

Radial bearing tolerances are shown in **Table 3.1** and **Table 3.2** (page 8).

● **Table 3.1** Tolerances of Inner Ring (JIS Class 5, Class 4, Class 2)

Unit: μm

Nominal bearing bore diameter d (mm)		Single plane mean bore diameter variation (1) Δd_{mp}						Bore diameter deviation (1) Δd_s				Single plane bore difference (1) V_{dsp}				Single plane mean bore diameter difference (1) V_{dmp}		
Over	Incl.	Class 5		Class 4		Class 2		Class 4		Class 2		Class 5		Class 4		Class 5	Class 4	Class 2
		High	Low	High	Low	High	Low	Diameter series				Diameter series				Max	Max	Max
								0,2				9	0,2	9	0,2			
								High	Low	High	Low	Max	Max	Max	Max			
2.5	10	0	-5	0	-4	0	-2.5	0	-4	0	-2.5	5	4	4	3	3	2	1.5
10	18	0	-5	0	-4	0	-2.5	0	-4	0	-2.5	5	4	4	3	3	2	1.5
18	30	0	-6	0	-5	0	-2.5	0	-5	0	-2.5	6	5	5	4	3	2.5	1.5
30	50	0	-8	0	-6	0	-2.5	0	-6	0	-2.5	8	6	6	5	4	3	1.5
50	80	0	-9	0	-7	0	-4	0	-7	0	-4	9	7	7	5	5	3.5	2
80	120	0	-10	0	-8	0	-5	0	-8	0	-5	10	8	8	6	5	4	2.5
120	150	0	-13	0	-10	0	-7	0	-10	0	-7	13	10	10	8	7	5	3.5
150	180	0	-13	0	-10	0	-7	0	-10	0	-7	13	10	10	8	7	5	3.5
180	250	0	-15	0	-12	0	-8	0	-12	0	-8	15	12	12	9	8	6	4

Unit: μm

Nominal bearing bore diameter d (mm)		Inner ring radial run-out of assembled bearing K_{ia}			Inner ring reference face runout with bore S_d			Assembled bearing inner ring reference face runout with raceway (2) S_{ia}			Deviation of a single ring width ΔB_s						Inner ring width variation V_{Bs}			
Over	Incl.	Class 5	Class 4	Class 2	Class 5	Class 4	Class 2	Class 5	Class 4	Class 2	Class 5		Class 4/Class 2		Class 5/Class 4 /Class 2		Class 5	Class 4	Class 2	
		Max	Max	Max	Max	Max	Max	Max	Max	Max	Max	Single bearing				Duplex bearing (3)		Max	Max	Max
												High	Low	High	Low	High	Low			
2.5	10	4	2.5	1.5	7	3	1.5	7	3	1.5	0	-40	0	-40	0	-250	5	2.5	1.5	
10	18	4	2.5	1.5	7	3	1.5	7	3	1.5	0	-80	0	-80	0	-250	5	2.5	1.5	
18	30	4	3	2.5	8	4	1.5	8	4	2.5	0	-120	0	-120	0	-250	5	2.5	1.5	
30	50	5	4	2.5	8	4	1.5	8	4	2.5	0	-120	0	-120	0	-250	5	3	1.5	
50	80	5	4	2.5	8	5	1.5	8	5	2.5	0	-150	0	-150	0	-250	6	4	1.5	
80	120	6	5	2.5	9	5	2.5	9	5	2.5	0	-200	0	-200	0	-380	7	4	2.5	
120	150	8	6	2.5	10	6	2.5	10	7	2.5	0	-250	0	-250	0	-380	8	5	2.5	
150	180	8	6	5	10	6	4	10	7	5	0	-250	0	-250	0	-380	8	5	4	
180	250	10	8	5	11	7	5	13	8	5	0	-300	0	-300	0	-500	10	6	5	

Note 1) Applies to bearings with cylindrical bore.

Note 2) Applies to ball bearings.

Note 3) Applies to the rings of single bearings made for mounted bearings.

Remark: The high deviation of bearing bore diameter of cylindrical bore bearings in Table 3.1 does not apply within a distance from the raceway ring face of $1.2 \times r$ (max) of the chamfer.

Bearing Selection

Bearing Life

Bearing Tolerance

Bearing Arrangement

Preload and Rigidity

Lubrication

Limiting Speeds

Shaft and Housing Design

Bearing Handling

Bearing Tolerance

● **Table 3.2** Tolerances of Outer Ring (JIS Class 5, Class 4, Class 2)

Unit: μm

Nominal bearing outside diameter D (mm)		Single plane mean outside diameter variation of outer ring ΔD_{mp}						Outside diameter deviation ΔD_s				Outside diameter variation in a single radial plane (1) V_{Dsp}					Mean outside diameter variation V_{Dmp}						
		Class 5		Class 4		Class 2		Class 4		Class 2		Class 5		Class 4		Class 2	Class 5	Class 4	Class 2				
Over	Incl.	High	Low	High	Low	High	Low	Diameter series				Diameter series					Max	Max	Max				
								0,2				9		0,2		9				0,2		0,2	
								High	Low	High	Low	Max	Max	Max	Max	Max				Max			
18	30	0	-6	0	-5	0	-4	0	-5	0	-4	6	5	5	4	4	3	2.5	2				
30	50	0	-7	0	-6	0	-4	0	-6	0	-4	7	5	6	5	4	4	3	2				
50	80	0	-9	0	-7	0	-4	0	-7	0	-4	9	7	7	5	4	5	3.5	2				
80	120	0	-10	0	-8	0	-5	0	-8	0	-5	10	8	8	6	5	5	4	2.5				
120	150	0	-11	0	-9	0	-5	0	-9	0	-5	11	8	9	7	5	6	5	2.5				
150	180	0	-13	0	-10	0	-7	0	-10	0	-7	13	10	10	8	7	7	5	3.5				
180	250	0	-15	0	-11	0	-8	0	-11	0	-8	15	11	11	8	8	8	6	4				
250	315	0	-18	0	-13	0	-8	0	-13	0	-8	18	14	13	10	8	9	7	4				
315	400	0	-20	0	-15	0	-10	0	-15	0	-10	20	15	15	11	10	10	8	5				

Unit: μm

Nominal bearing outside diameter D (mm)		Outer ring radial runout of assembled bearing K_{ea}			Variation of outside surface generatrix inclination with outer ring reference S_D			Assembled bearing outer ring reference face runout with raceway (2) S_{ea}			Deviation of a single ring width ΔC_s	Outer ring width variation V_{Cs}		
		Class 5	Class 4	Class 2	Class 5	Class 4	Class 2	Class 5	Class 4	Class 2		Class 5	Class 4	Class 2
Over	Incl.	Max	Max	Max	Max	Max	Max	Max	Max	Max	Corresponds to the values of ΔB_s of the inner ring being matched with it.	Max	Max	Max
		18	30	6	4	2.5	8	4	1.5	8		5	2.5	5
30	50	7	5	2.5	8	4	1.5	8	5	2.5	5	2.5	1.5	
50	80	8	5	4	8	4	1.5	10	5	4	6	3	1.5	
80	120	10	6	5	9	5	2.5	11	6	5	8	4	2.5	
120	150	11	7	5	10	5	2.5	13	7	5	8	5	2.5	
150	180	13	8	5	10	5	2.5	14	8	5	8	5	2.5	
180	250	15	10	7	11	7	4	15	10	7	10	7	4	
250	315	18	11	7	13	8	5	18	10	7	11	7	5	
315	400	20	13	8	13	10	7	20	13	8	13	8	7	

Note 1) Applies to open type bearings.

Note 2) Applies to ball bearings.

Remark: The low outside diameter deviation of bearings in Table 3.2 does not apply within a distance from the ring face of $1.2 \times r$ (max) of the chamfer.

3-2 Tolerances and Permissible Values of Angular Contact Ball Bearings for Thrust Loads (TAH/TBH Series)

Except for the outside diameter of outer ring outside diameter, accuracy of angular contact ball bearings for thrust loads conforms to JIS Class 4. Outside diameter of outer ring tolerances is as shown in [Table 3.3](#).

● **Table 3.3** Tolerance of Outside Diameter

Unit: μm

Nominal bearing outside diameter D (mm)		Outside diameter deviation ΔD_s	
Over	Incl.	High	Low
50	80	-30	-49
80	120	-36	-58
120	180	-43	-68
180	250	-50	-79
250	315	-56	-88

3-3 Tolerances of Cross Tapered Roller Bearings

Tolerances for cross tapered roller bearings is shown in [Table 3.4](#) and [Table 3.5](#).

● **Table 3.4** XRN Series Inner Ring and Outer Ring tolerances

Unit: μm

Bearing no.	Single plane mean bore diameter variation Δd_{mp}		Single plane mean outside diameter variation of outer ring ΔD_{mp}		Variation of assembled height Ts		Outer ring run-out (Max)	
	High	Low	High	Low	High	Low	Radial run-out	Sideface runout
150XRN23	0	-13	0	-15	+350	-250	7	7
200XRN28	0	-15	0	-18	+350	-250	7	7
250XRN33	0	-15	0	-18	+350	-250	7	7
250XRN35	0	-10	0	-13	+350	-250	9	9
300XRN40	0	-13	0	-15	+350	-250	7	7
310XRN42	0	-13	0	-15	+350	-250	7	7
0330XRN045	+25	0	+25	0	+350	-250	8	8
350XRN47	0	-13	0	-15	+350	-250	9	9
375XRN49	0	-13	0	-15	+350	-250	7	7
400XRN55	0	-13	0	-18	+350	-250	9	9
0457XRN060	+25	0	+25	0	+380	-380	9	9
580XRN76	+25	0	+38	0	+406	-406	10	10
0685XRN091	+38	0	+38	0	+508	-508	12	12
950XRN117	0	-75	0	-75	+750	-750	14	14

● **Table 3.5** XRG (XRGV) Series Inner Ring and Outer Ring Tolerances

Unit: μm

Bearing no.	Single plane mean bore diameter variation Δd_{mp}		Single plane mean outside diameter variation of outer ring ΔD_{mp}		Variation of assembled height Ts		Inner ring run-out (Max)	
	High	Low	High	Low	High	Low	Radial run-out	Sideface runout
130XRG23	0	-10	0	-15	+350	-250	6	7
140XRGV20	0	-13	0	-15	+350	-350	5	5
150XRG23	0	-13	0	-15	+350	-250	6	7
200XRGV028	0	-15	0	-18	+350	-350	7	7
320XRG43	0	-13	0	-15	+350	-250	7	7
480XRGV66	0	-45	-70	-100	+450	-450	11	11

Bearing Selection

Bearing Life

Bearing Tolerance

Bearing Arrangement

Preload and Rigidity

Lubrication

Limiting Speeds

Shaft and Housing Design

Bearing Handling

Bearing Tolerance

3-4 Ball Screw Support Bearing (TAB Series) Tolerances

Tolerances for ball screw support (TAB Series) is shown in [Table 3.6](#) and [Table 3.7](#).

● **Table 3.6** Tolerances for Inner Ring (Including Outer Ring Width and Outer Ring Sideface Runout Reference to Raceway)

Unit: μm

Nominal bearing bore diameter d (mm)		Single plane mean bore and bore variation $\Delta d_{mp}, \Delta d_s$				Bore diameter variation in a single radial plane V_{dp}		Mean bore diameter variation V_{dmp}		Deviation of a single inner ring width (or a single outer ring width) $\Delta B_s, \Delta C_s$		Width deviation of inner ring V_{Bs}		Radial runout of assembled bearing inner ring K_{ia}		Side face runout S_d with reference to bore		Side face runout with reference to raceway of assembled bearing inner ring S_{ia} and of assembled bearing outer ring S_{ea}	
		Class 5		Class 4		Class 5	Class 4	Class 5	Class 4	Class 5/Class 4		Class 5	Class 4	Class 5	Class 4	Class 5	Class 4	Class 5	Class 4
Over	Incl.	High	Low	High	Low	Max	Max	Max	Max	High	Low	Max	Max	Max	Max	Max	Max	Max	Max
10	18	0	-5	0	-4	4	3	3	2	0	-80	5	2.5	4	2.5	7	3	4	2
18	30	0	-6	0	-5	5	4	3	2.5	0	-120	5	2.5	4	3	8	4	5	2.5
30	50	0	-8	0	-6	6	5	4	3	0	-120	5	3	5	4	8	4	6	2.5
50	80	0	-9	0	-7	7	5	5	3.5	0	-150	6	4	5	4	8	5	7	2.5

● **Table 3.7** Tolerances for Outer Ring

Unit: μm

Nominal bearing outside diameter D (mm)		Single plane mean outside diameter variation of outer ring $\Delta D_{mp}, \Delta D_s$				Outside diameter variation in a single radial plane V_{Dp}		Mean outside diameter variation V_{Dmp}		Variation of outside surface generatrix inclination with outer ring reference V_{Cs}		Radial runout of assembled bearing outer ring K_{ea}		Outside Inclination of outer ring S_D	
		Class 5		Class 4		Class 5	Class 4	Class 5	Class 4	Class 5	Class 4	Class 5	Class 4	Class 5	Class 4
Over	Incl.	High	Low	High	Low	Max	Max	Max	Max	Max	Max	Max	Max	Max	
30	50	0	-7	0	-6	5	5	4	3	5	2.5	7	5	8	4
50	80	0	-9	0	-7	7	5	5	3.5	6	3	8	5	8	4
80	120	0	-10	0	-8	8	6	5	4	8	4	10	6	9	5

For the TAB Series flush ground type, strict tolerances are established for outside diameter and bore diameter to minimize differences within duplex bearings. ([Table 3.8](#), [Table 3.9](#))

● **Table 3.8** Tolerances for Bore Diameter of Inner Ring (Class 4 Flush Ground)

Unit: μm

Nominal bearing bore diameter d (mm)		Single plane mean bore diameter variation $\Delta d_{mp}, \Delta d_s$			
		Class 4 flush ground			
Over	Incl.	High		Low	
10	18	0		-4	
18	30	0		-4	
30	50	0		-4	
50	80	0		-5	

Tolerances for other than bore diameter conforms to Class 4 in Table 3.6.

● **Table 3.9** Tolerances for Outside Diameter of Outer Ring (Class 4 Flush Ground)

Unit: μm

Nominal bearing outside diameter D (mm)		Single plane mean outside diameter variation of outer ring $\Delta D_{mp}, \Delta D_s$			
		Class 4 flush ground			
Over	Incl.	High		Low	
30	50	0		-4	
50	80	0		-5	
80	120	0		-6	

Tolerances for other than outside diameter conforms to Class 4 in Table 3.7.

3-5 Tolerances for Ball Screw Support Bearing (TAF Series)

Tolerances for ball screw support (TAF Series) is shown in Table 3.10 and Table 3.11.

● Table 3.10 Tolerances for Inner Ring (Including Outer Ring Width, JIS Class 5)

Nominal bearing bore diameter d (mm)		Single plane mean bore diameter variation Δd_{mp}		Bore diameter variation in a single radial plane V_{dp}	Mean bore diameter variation V_{dmp}	Outer and inner ring width variation $\Delta B_s, \Delta C_s$		Width deviation VBS of Inner Ring V_{Bs}	Radial runout of assembled bearing inner ring K_{ia}	Side face runout with reference to bore S_d	Side face runout with reference to raceway of assembled bearing inner ring S_{ia}
Over	Incl.	High	Low	Max	Max	High	Low	Max	Max	Max	Max
18	30	0	-6	5	3	0	-120	5	4	8	8
30	50	0	-8	6	4	0	-120	5	5	8	8
50	80	0	-9	7	5	0	-150	6	5	8	8
80	120	0	-10	8	5	0	-200	7	6	9	9

Unit: μm

● Table 3.11 Tolerances for Outer Ring (JIS Class 5)

Nominal bearing outside diameter D (mm)		Single plane mean outside diameter variation of outer ring ΔD_{mp}		Outside diameter variation in a single radial plane V_{Dp}	Mean outside diameter variation V_{Dmp}	Outer ring width variation V_{Cs}	Radial runout of assembled bearing outer ring K_{ea}	Variation of outside surface generatrix inclination with outer ring reference S_D	Assembled bearing outer ring reference face runout with raceway S_{ea}
Over	Incl.	High	Low	Max	Max	Max	Max	Max	Max
50	80	0	-9	7	5	6	8	8	10
80	120	0	-10	8	5	8	10	9	11
120	150	0	-11	8	6	8	11	10	13
150	180	0	-13	10	7	8	13	10	14
180	250	0	-15	11	8	10	15	11	15
250	315	0	-18	14	9	11	18	13	18

Unit: μm

3-6 Tolerances for Tapered Bores (Cylindrical Roller Bearings)

Tolerances for tapered bores (Cylindrical roller bearings) is specified by JIS. Since JIS tolerances are rather broad, NACHI defines its own narrower range for precision bearings.

● Table 3.12 Tolerances for Tapered Bores (Cylindrical Roller Bearings)

Nominal bearing bore diameter d (mm)		Mean bore diameter deviation at theoretical small end of a tapered bore								Bore diameter variation in a single plane radial plane	
		Δd_{mp}				$\Delta d_{1mp} - \Delta d_{mp}$				V_{dp}	
		Class 5		Class 4		Class 5		Class 4		Class 5	Class 4
Over	Incl.	High	Low	High	Low	High	Low	High	Low	Max	Max
18	30	+10	0	+6	0	+5	0	+3	0	3	3
30	50	+12	0	+8	0	+5	0	+4	0	4	3
50	80	+15	0	+9	0	+6	0	+4	0	5	4
80	120	+20	0	+10	0	+7	0	+5	0	5	4
120	180	+25	0	+13	0	+10	0	+7	0	7	5
180	250	+30	0	+15	0	+12	0	+9	0	8	6
250	315	+35	0	+18	0	+15	0	+11	0	9	9
315	400	+40	0	+23	0	+16	0	+12	0	12	12

Unit: μm

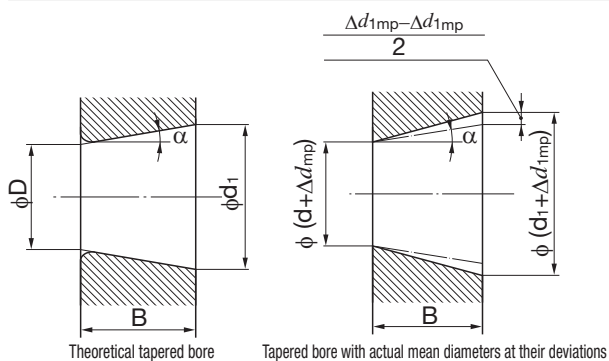

● Figure 3.1 Tapered Bores of Cylindrical Roller Bearings

- D : Nominal bearing bore diameter
- d_1 : Basic diameter at theoretical large end of tapered bore
- $d_1 = d + \frac{1}{12}B$
- Δd_{mp} : Mean bore diameter deviation at theoretical small end of tapered bore
- Δd_{1mp} : Mean bore diameter deviation at theoretical large end of tapered bore
- B : Nominal bearing inner ring width
- α : Nominal taper angle (half of cone angle)

4

Bearing Arrangement











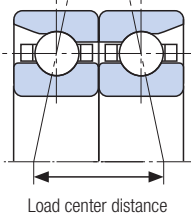
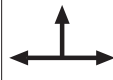

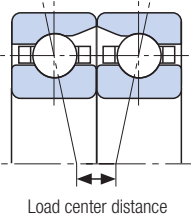
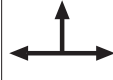

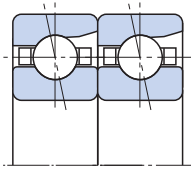

4-1 Duplex Bearing Features

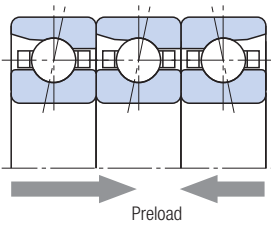
In addition to a duplex set, precision angular contact ball bearings and ball screw support bearings are available in 3-row duplex and 4-row duplex. Bearings in these combinations are manufactured in sets with a desired preload and dimensional variation of outside diameter and bore diameter within the bearing sets are controlled.

Because of this, avoid switching the duplex bearings in a set with other bearings.

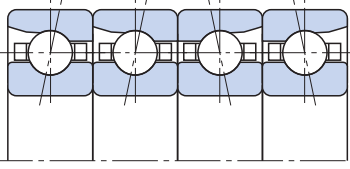
Table 4.1 shows the main combinations and describes their characteristics.

● **Table 4.1** Main Combinations and Characteristics

Main combinations	Cross section	Load capability	Moment load rigidity	Speed	Features
Back-to-back (DB)					<ul style="list-style-type: none"> ● Radial loads and axial loads in both directions can be applied. ● The load center distance is long, so moment load capability is high. ● Misalignment or other mounting error increases internal load and tends to generate premature flaking.
Face-to-face (DF)					<ul style="list-style-type: none"> ● The load center distance is decreased, so moment load capability is low. ● Since moment load capability is low, increase in internal load due to misalignment is kept under control. Because of this, this combination is suitable when misalignment can not be avoided or when shaft deflection is large because of the load.
Tandem (DT)					<ul style="list-style-type: none"> ● Radial loads and axial loads can be applied in one direction. ● Since the axial load capability is double that of a single row, this combination is suitable for large axial load in one-direction.
3-row duplex (FFB)					<ul style="list-style-type: none"> ● Radial loads and axial loads in both direction can be applied. ● The axial load capability is double that of a single-row, but preload is not distributed uniformly to each bearing, and the single-row configuration is double that of the two-row configuration. This non-uniform preload distribution makes appropriate preload settings difficult at high speed rotation.
4-row duplex (FFBB)					<ul style="list-style-type: none"> ● Radial loads and axial loads in both directions can be applied. ● Compared to the back-to-back configuration under the same preload clearance, preload is doubled and rigidity is greater.

4-2 Mounting and Mounting Symbols

The symbols used for each type of combination are shown in **Table 4.1**. The arrangement sequence and direction of the load are important for duplex bearings. Because of this, the outside surface of the outer ring of the duplex bearings in Figure 4.1 has a combination

mark (\llcorner) that can be used to check the arrangement sequence. If the bearings are arranged in the correct sequence, the marks on the outside surface of each bearing appear as a " \llcorner "

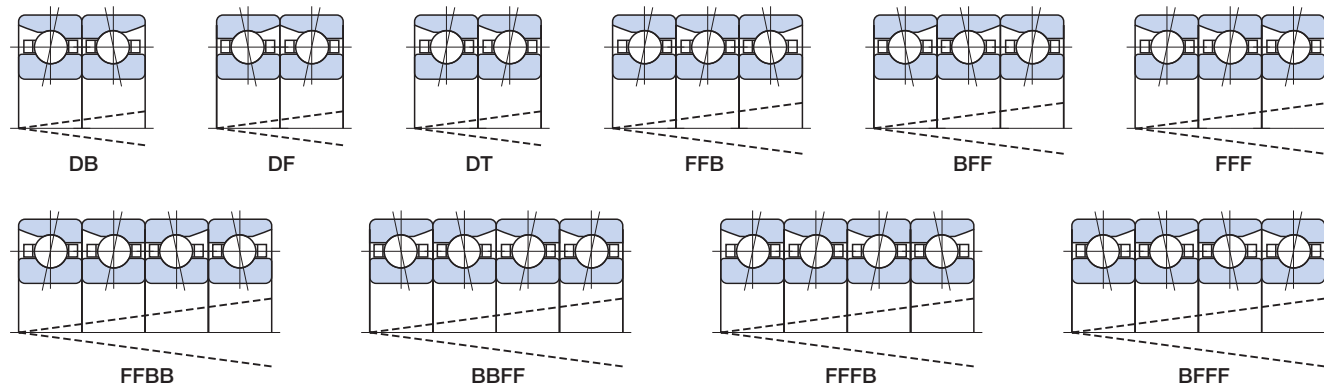

● **Figure 4.1** Set Combinations and Outer Ring Combination Marks

4-3 Flush Ground Angular Contact Ball Bearings

For flush ground angular contact ball bearings, the face side width dimension (A_f) and back side width dimension (A_b) are controlled to be the same. Therefore, desired preload is obtained in any set of combination. (**Figure 4.2**).

Flush ground angular contact ball bearings are delivered singularly (suffix symbol; U) or in a duplex set (suffix symbol: DU). Duplex sets have a small dimensional variation in bore diameter and outer diameter. When using U series in a combination, select a bearing whose actual measured outside diameter and bore diameter values are close to each other.

For the ball screw support bearing TAB Series flush ground type, a combination (\llcorner) mark is put on the outside surface of the outer ring. For information about set combinations and the combination marks, see **Figure 4.3**.

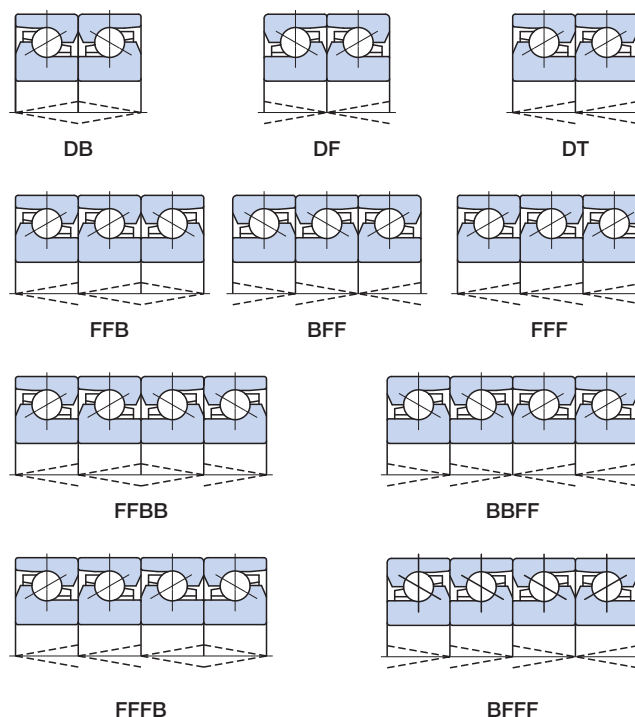

● **Figure 4.3** Flush Ground Bearing Set Combinations and Combination Marks

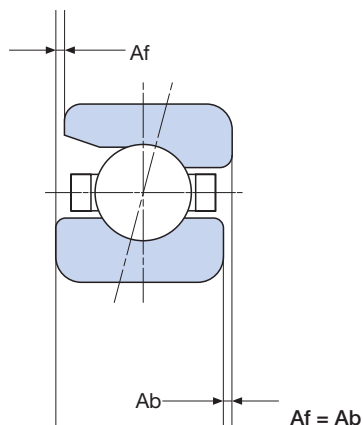

● **Figure 4.2** Flush Ground Angular Contact Ball Bearing

5

Preload and Rigidity

5-1 Preload Objectives

Rolling contact bearings generally have internal clearance suitable for operating conditions, angular contact ball bearings also may be installed with appropriate predetermined negative clearance (axial preload).

This is known as "preload". Care is required when determining preloads. An improper preload can increase friction torque, raise temperature, cause abnormal sounds, shorten bearing life, and cause other problems.

The following is a list of what can be achieved by preloading.

- Reduced axial displacement due to external force and greater axial rigidity
- Prevention of vibration and noise and increased speed due to greater axial rigidity
- Less chance of fretting due to external vibration
- Smooth rolling rotation
- Lower noise and less heat due to ball centrifugal force and gyro-moment

Gyro-moment

The balls of an angular contact ball bearing spin around rotational axes while they revolve around an orbital axis (axis line). An angle is performed between the rotational axis and orbital axis, and a moment is generated when a ball attempts to revolve on the center

of the two different axes. This is called a "gyro-moment" (Figure 5.1). The size of the gyro-moment is proportional to rotational angular velocity and orbital angular velocity. Gyro-moment is small enough to be ignored at low-speed rotation, but heat generation due to slipping caused by gyro-motion in the high-speed rotation range cannot be ignored. In order to suppress slipping caused by gyro-motion, friction (ball load x coefficient of friction) between the balls and raceway surface must be maintained. This means that there are times when minimal preload can be chosen.

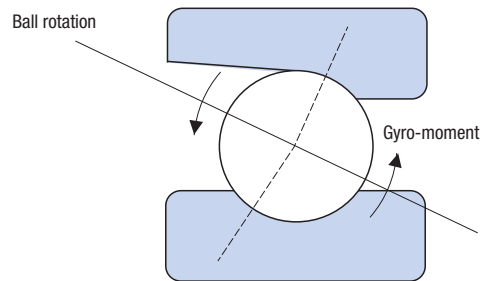

● Figure 5.1 Gyro-moment

5-2 Preload Methods

Preloading combination bearings is broadly divided between fixed-position preload and fixed-pressure preload.

Table 5.1 (page 15) shows graphic examples and describes the characteristics of each type of preloading.

A cylindrical roller bearing with tapered bore also may be used with radial preload (negative radial clearance) applied. However, caution is required because radial preload that is too large dramatically reduces service life (Figure 5.2).

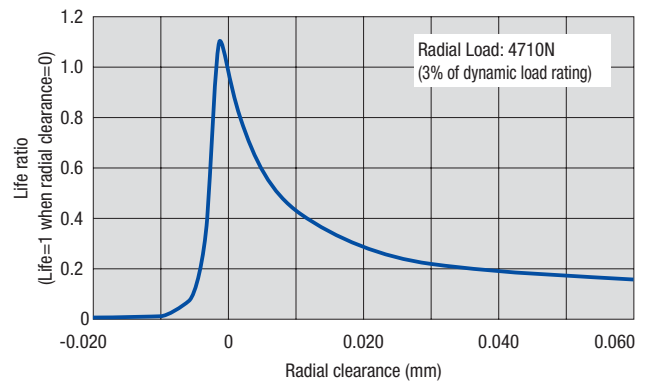

● Figure 5.2 Cylindrical Roller Bearing (NN3020) Radial Clearance and Service Life

5-3 Measuring Preload

① Axial load measurement method

For spring preloading (fixed-pressure preload), the preload is known if the spring displacement is known.

For nut preloading (fixed-position preload), the preload can be determined based on the relationship between nut tightening torque and tightening force. However, that caution is required because there is wide variation in the relationship between nut tightening torque and tightening force due to accuracy and roughness of the threaded portion.

② Axial displacement measurement method

The preload can be determined based on the relationship between the axial load on the bearing and axial displacement.

③ Bearing starting friction torque measurement method

To perform this measurement, your first need to create a graph of the load and starting torque of the bearing itself. However, caution is required because of variation due to bearing type, lubrication conditions, etc.

● Table 5.1 Preload Methods

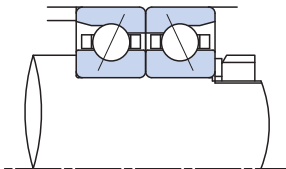
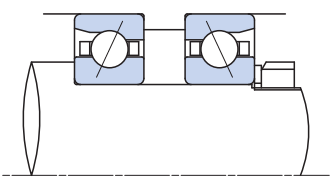
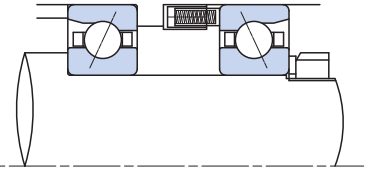
Preload methods	Design example	Features
Fixed-position preload	 <p>Method using either a duplex bearing with pre-adjusted preload or a dimension adjusted spacer</p>	<ul style="list-style-type: none"> ● Since bearing spread is used, the prescribed preload can be obtained simply by tightening a nut. ● Fit causes preload inconsistency. ● Heat generation causes preload inconsistency. ● Applying an axial load that is too great can cause loss of preload.
	 <p>Preload adjustment method using nut tightening</p>	<ul style="list-style-type: none"> ● Uniform preload, even if fit is inconsistent ● Further tightening possible ● Heat generation causes preload inconsistency. ● Applying an axial load that is too great can cause loss of preload.
Fixed-pressure preload	 <p>Method using spring</p>	<ul style="list-style-type: none"> ● Constant uniform preload while running ● No loss of preload ● Suitable for high speeds ● In principle, one-direction axial load can be applied ● Inferior rigidity compared to fixed-position preload of the same preload

Bearing Selection

Bearing Life

Bearing Tolerance

Bearing Arrangement

Preload and Rigidity

Lubrication

Limiting Speeds

Shaft and Housing Design

Bearing Handling

5-4 Preload Effect

Graphic analysis of load distribution and axial displacement on two bearings when preload is applied with an external load, as shown in **Figure 5.3**, is performed as described below.

- ① Graph the Axial Load T - Axial Deflection δa curve for bearing A.
- ② Locating preload T_p on the T-axis, determine the point of intersection for bearing A curve, and then graph the T - δa curve for Bearing B point P.
- ③ Link the above two curves horizontally along the T-axis for a length that corresponds to the external load value T_w .
- ④ Loads T_a and T_b , which correspond to the points of intersection of the lines, are the loads of each bearing under external load conditions.

- ⑤ Axial displacement is given as bearing B displacement δw . (Bearing B displacement is the displacement for T_p subtracted from the displacement for T_b .)

The reason for this is that the displacements of two preloaded bearings are not uniform within the range that the preload does not become zero due to outside load. (Figure 5.3 is uniform). In other words, bearing A is displaced only as much as bearing B is displaced by the external load.

After external load becomes great and preload is eliminated, bearing B load T_b becomes the same as external load T_w , and bearing A load is eliminated. The size of the external load when this preload is eliminated is indicated in Figure 5.3 as T_{po} .

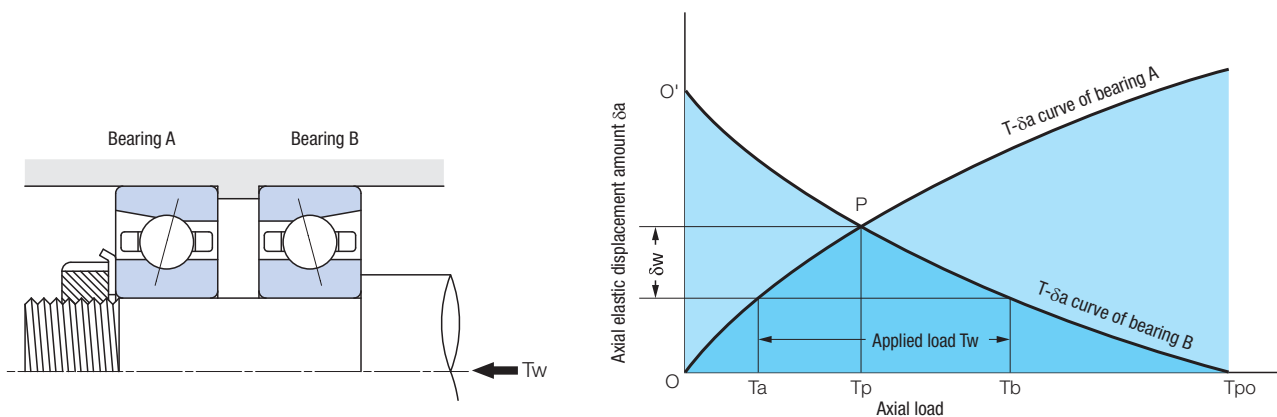

● Figure 5.3 Fixed-position Preload

Preload and Rigidity

5-5 Standard Preload and Axial Rigidity

5.5.1 Angular Contact Ball Bearing

Preloads and axial rigidity for face-to-face and back-to-back duplex mounting are shown in **Table 5.3 1** to **6** (pages 16 through 18). Preloads for multiple-row arrangements can be obtained by multiplying by the coefficients in **Table 5.2**.

● **Table 5.2** Preload Factors for Multiple-row Arrangements

3-row arrangement	4-row arrangement	
FFB-BFF	FFFB-BFFF	FFBB-BBFF
1.36	1.57	2

● **Table 5.3**

1 7900C Series with 15° Contact Angle

Bore diameter number	E (extra-light preload)		L (light preload)		M (medium preload)	
	Preload (N)	Axial rigidity (N/μm)	Preload (N)	Axial rigidity (N/μm)	Preload (N)	Axial rigidity (N/μm)
00	5	10	15	15	30	20
01	7	12	20	18	40	24
02	8	13	25	21	50	28
03	8	13	25	21	50	28
04	15	19	40	27	80	36
05	15	19	50	33	100	43
06	15	21	50	36	100	48
07	25	28	70	41	140	56
08	25	28	80	44	155	60
09	35	35	100	53	195	70
10	35	35	100	56	195	72

2 7900AC Series with 25° Contact Angle

Bore diameter number	L (light preload)		M (medium preload)		H (heavy preload)	
	Preload (N)	Axial rigidity (N/μm)	Preload (N)	Axial rigidity (N/μm)	Preload (N)	Axial rigidity (N/μm)
00	20	33	88	59	196	82
01	20	33	98	65	216	90
02	29	42	108	67	235	94
03	29	42	118	74	255	102
04	59	65	235	107	490	149
05	69	69	265	120	560	169
06	78	78	294	134	628	190
07	88	88	323	147	785	212
08	88	98	412	165	1,000	244
09	98	109	470	188	1,040	260
10	118	118	520	208	1,140	284

3 7000C Series with 15° Contact Angle

Bore diameter number	E (extra-light preload)		L (light preload)		M (medium preload)		H (heavy preload)	
	Preload (N)	Axial rigidity (N/μm)	Preload (N)	Axial rigidity (N/μm)	Preload (N)	Axial rigidity (N/μm)	Preload (N)	Axial rigidity (N/μm)
00	20	13	50	20	100	29	145	37
01	20	14	50	21	100	31	145	39
02	20	15	50	23	100	34	145	42
03	20	16	50	25	100	35	145	43
04	50	23	100	33	195	48	295	59
05	50	26	100	36	195	50	295	63
06	50	27	100	38	195	53	390	75
07	70	33	145	46	295	64	390	75
08	70	34	145	49	295	68	590	98
09	70	34	145	49	295	68	590	98
10	70	36	145	51	295	70	590	100
11	100	43	195	56	390	78	785	112
12	100	43	195	58	390	82	785	115
13	100	47	195	61	390	85	785	123
14	145	57	295	75	590	105	1170	149
15	145	57	295	77	590	107	1170	153
16	145	57	295	75	590	105	1170	149
17	195	65	390	89	785	125	1470	171
18	195	65	390	87	785	121	1470	165
19	195	68	390	91	785	125	1470	171
20	195	70	390	93	785	127	1470	173

4 7000AC Series with 25° Contact Angle

Bore diameter number	L (light preload)		M (medium preload)		H (heavy preload)	
	Preload (N)	Axial rigidity (N/μm)	Preload (N)	Axial rigidity (N/μm)	Preload (N)	Axial rigidity (N/μm)
00	39	39	118	62	314	95
01	39	44	127	67	343	104
02	49	49	157	83	353	118
03	59	59	216	98	520	144
04	59	59	274	110	608	152
05	108	83	392	140	804	187
06	118	91	441	158	892	208
07	127	98	539	174	1,156	236
08	147	113	617	193	1,176	256
09	216	135	745	213	1,646	300
10	225	141	784	224	1,744	317
11	314	157	1,040	254	2,078	341
12	333	167	1,098	268	2,205	362
13	363	191	1,225	299	2,450	402
14	392	196	1,460	332	3,010	443
15	412	206	1,530	348	3,155	464
16	529	230	1,900	373	3,880	504
17	549	239	1,990	390	4,080	530
18	676	260	2,185	405	4,600	555
19	706	272	2,300	427	4,810	580
20	745	287	2,400	445	5,050	608

Bearing Selection

Bearing Life

Bearing Tolerance

Bearing Arrangement

Preload and Rigidity

Lubrication

Limiting Speeds

Shaft and Housing Design

Bearing Handling

Preload and Rigidity

5 7200C Series with 15° Contact Angle

Bore diameter number	E (extra-light preload)		L (light preload)		M (medium preload)		H (heavy preload)	
	Preload (N)	Axial rigidity (N/μm)	Preload (N)	Axial rigidity (N/μm)	Preload (N)	Axial rigidity (N/μm)	Preload (N)	Axial rigidity (N/μm)
00	30	16	70	24	145	36	195	42
01	30	16	70	24	145	36	195	42
02	30	17	70	25	145	38	195	44
03	30	17	70	25	145	37	195	44
04	70	25	145	37	295	53	490	71
05	70	29	145	41	295	58	490	77
06	70	29	145	41	295	58	590	83
07	100	35	195	47	490	74	590	82
08	100	36	195	49	490	77	785	98
09	100	36	195	50	490	77	785	98
10	100	39	195	52	490	80	785	102
11	145	46	295	63	590	88	980	114
12	145	46	295	61	590	84	980	109
13	145	47	295	64	590	88	980	113
14	195	54	390	73	785	102	1470	139
15	195	56	390	75	785	105	1470	144
16	195	58	390	77	785	105	1470	143
17	295	68	490	85	980	117	1960	166
18	295	67	490	83	980	114	1960	161
19	295	68	490	85	980	114	1960	159
20	295	68	490	85	980	115	1960	159

6 7200AC Series with 25° Contact Angle

Bore diameter number	L (light preload)		M (medium preload)		H (heavy preload)	
	Preload (N)	Axial rigidity (N/μm)	Preload (N)	Axial rigidity (N/μm)	Preload (N)	Axial rigidity (N/μm)
00	39	44	186	78	412	108
01	39	44	196	78	421	111
02	69	57	265	95	530	129
03	78	60	274	98	628	143
04	118	74	420	120	853	164
05	147	92	430	139	922	188
06	157	92	628	165	1,314	227
07	225	119	853	194	1,890	270
08	255	127	950	216	1,960	288
09	333	145	1,200	241	2,470	321
10	353	153	1,295	259	2,655	345
11	460	177	1,500	278	3,145	379
12	540	186	1,600	280	3,410	383
13	600	206	2,069	328	4,175	440
14	610	210	2,108	335	4,260	444
15	650	223	2,255	358	4,310	464
16	800	241	2,725	389	5,730	531
17	940	262	2,970	407	6,090	549
18	1,200	285	3,745	441	7,620	591
19	1,235	294	3,870	450	8,140	612
20	1,588	324	4,930	503	9,950	677

5.5.2 High-speed Angular Contact Ball Bearings

● **Table 5.4** BNH000 Series with 15° Contact Angle

Bore diameter number	Bore diameter (mm)	L (standard preload)	
		Preload (N)	Axial rigidity (N/μm)
07	35	78.5	44
08	40	98.1	49
09	45	98.1	52
10	50	98.1	54
11	55	147	61
12	60	147	64
13	65	147	67
14	70	245	88
15	75	245	91
16	80	294	98
17	85	294	98
18	90	392	115
19	95	392	119
20	100	392	123
21	105	490	136
22	110	588	144
24	120	588	147
26	130	785	163
28	140	834	174
30	150	1080	200
32	160	1180	206
34	170	1370	221

5.5.3 Thrust Load Angular Contact Ball Bearings

● **Table 5.5**

1 TAH Series with 30° Contact Angle

Nominal bore diameter (mm)	M (medium preload)	
	Preload (N)	Axial rigidity (N/μm)
50	294	226
55	392	262
60	392	280
65	392	280
70	588	327
75	588	327
80	686	361
85	686	361
90	1080	449
95	1080	449
100	1080	469
105	1180	490
110	1370	528
120	1470	566
130	1860	621
140	1960	654
150	2450	721
160	2650	779
170	3040	800

2 TBH Series with 40° Contact Angle

Nominal bore diameter (mm)	M (medium preload)	
	Preload (N)	Axial rigidity (N/μm)
50	539	415
55	686	458
60	686	490
65	686	528
70	1080	599
75	1080	599
80	1270	671
85	1270	671
90	1860	776
95	1860	810
100	1860	847
105	2060	858
110	2450	943
120	2550	1,020
130	3330	1,111
140	3530	1,177
150	4310	1,269
160	4510	1,367
170	5300	1,431

Bearing Selection

Bearing Life

Bearing Tolerance

Bearing Arrangement

Preload and Rigidity

Lubrication

Limiting Speeds

Shaft and Housing Design

Bearing Handling

Preload and Rigidity

5.5.4 Ball Screw Support Bearings

● Table 5.6

1 TAB Series with 60° Contact Angle Standard Preload: M (Medium)

Bearing no.	2-row arrangement			3-row arrangement			4-row arrangement					
	DB/DF			BFF/FFB			BBFF/FFBB			BFFF/FFFB		
	Preload (N)	Axial rigidity (N/μm)	Starting torque (N-cm)	Preload (N)	Axial rigidity (N/μm)	Starting torque (N-cm)	Preload (N)	Axial rigidity (N/μm)	Starting torque (N-cm)	Preload (N)	Axial rigidity (N/μm)	Starting torque (N-cm)
15TAB04	2160	735	15	2940	1080	20	4310	1470	30	3430	1320	25
17TAB04	2160	735	15	2940	1080	20	4310	1470	30	3430	1320	25
20TAB04	2160	735	15	2940	1080	20	4310	1470	30	3430	1320	25
25TAB06	3330	981	20	4510	1470	27	6670	1960	40	5200	1910	30
30TAB06	3330	981	20	4510	1470	27	6670	1960	40	5200	1910	30
35TAB07	3920	1230	25	5300	1770	35	7840	2350	50	6180	2300	40
40TAB07	3920	1230	25	5300	1770	35	7840	2350	50	6180	2300	40
40TAB09	5200	1320	50	7060	1910	68	10400	2550	100	8140	2500	80
45TAB07	4120	1270	30	5590	1910	40	8240	2550	60	6470	2500	45
45TAB10	5980	1470	60	8140	2160	82	12000	2890	120	9410	2790	95
50TAB10	6280	1520	65	8530	2260	88	12600	3040	130	9810	2940	100
55TAB10	6280	1520	65	8530	2260	88	12600	3040	130	9810	2940	100
55TAB12	7060	1770	70	9610	2550	95	14100	3480	140	11100	3380	110
60TAB12	7060	1770	70	9610	2550	95	14100	3480	140	11100	3380	110

Note) Starting torque shows values for an open type and non-contact seal type with grease lubrication.

2 TAF Series with 50° or 55° Contact Angle Standard Preload: M (Medium)

Bearing no.	2-row arrangement			3-row arrangement			4-row arrangement					
	DB/DF			BFF/FFB			BBFF/FFBB			BFFF/FFFB		
	Preload (N)	Axial rigidity (N/μm)	Starting torque (N-cm)	Preload (N)	Axial rigidity (N/μm)	Starting torque (N-cm)	Preload (N)	Axial rigidity (N/μm)	Starting torque (N-cm)	Preload (N)	Axial rigidity (N/μm)	Starting torque (N-cm)
25TAF06	1670	555	20	2270	805	27	3340	1110	40	2620	1060	30
30TAF07	1860	642	20	2530	944	27	3720	1284	40	2920	1180	30
35TAF09	3700	908	55	5030	1340	75	7400	1816	110	5810	1680	85
40TAF09	3700	908	55	5030	1340	75	7400	1816	110	5810	1680	85
40TAF11	4600	1020	80	6250	1530	110	9200	2040	160	7220	1960	125
45TAF11	4600	1020	80	6250	1530	110	9200	2040	160	7220	1960	125
50TAF11	4600	1020	80	6250	1530	110	9200	2040	160	7220	1960	125
60TAF13	5200	1130	105	7070	1680	145	10400	2260	210	8160	2140	165
60TAF17	8300	1440	215	11300	2110	290	16600	2880	430	13000	2660	340
80TAF17	8300	1440	215	11300	2110	290	16600	2880	430	13000	2660	340
100TAF21	13200	1970	485	17900	2940	660	26400	3940	970	20700	4160	760
120TAF03	19600	2550	700	26600	3810	950	39200	5100	1400	30800	4810	1100

Note) Starting torque shows values with grease lubrication.

5.5.5 Radial Internal Clearance for Multiple-row Cylindrical Roller Bearings

The radial internal clearance for multiple-row cylindrical roller bearings is specified by JIS, NACHI defines its own narrower range

in order to maximize rotation accuracy. The radial internal clearances for cylindrical bore bearings and tapered bore bearings are shown in Table 5.7. Caution is required when handling and installing bearings with non-interchangeable clearances, because there is no interchangeability with another bearing's outer ring or inner ring.

● Table 5.7

1 Cylindrical Bore Bearing Non-interchangeable Clearance

Unit: μm

Nominal bearing bore diameter d (mm)		Cylindrical bore bearing clearance (non-interchangeable)							
		C1na		C2na		Cna		C3na	
Over	Incl.	Min	Max	Min	Max	Min	Max	Min	Max
24	30	0	10	10	25	25	35	40	50
30	40	0	12	12	25	25	40	45	55
40	50	0	15	15	30	30	45	50	65
50	65	0	15	15	35	35	50	55	75
65	80	0	20	20	40	40	60	70	90
80	100	0	25	25	45	45	70	80	105
100	120	0	25	25	50	50	80	95	120
120	140	0	30	30	60	60	90	105	135
140	160	0	35	35	65	65	100	115	150
160	180	0	35	35	75	75	110	125	165
180	200	0	40	40	80	80	120	140	180
200	225	0	45	45	90	90	135	155	200
225	250	0	50	50	100	100	150	170	215
250	280	0	55	55	110	110	165	185	240
280	315	0	60	60	120	120	180	205	265
315	355	0	65	65	135	135	200	225	295

2 Tapered Bore Bearing Non-interchangeable Clearance

Unit: μm

Nominal bearing bore diameter d (mm)		Tapered bore bearing clearance (non-interchangeable)					
		C9na		C1na		C2na	
Over	Incl.	Min	Max	Min	Max	Min	Max
24	30	5	10	15	25	25	35
30	40	5	12	15	25	25	40
40	50	5	15	17	30	30	45
50	65	5	15	20	35	35	50
65	80	10	20	25	40	40	60
80	100	10	25	35	55	45	70
100	120	10	25	40	60	50	80
120	140	15	30	45	70	60	90
140	160	15	35	50	75	65	100
160	180	15	35	55	85	75	110
180	200	20	40	60	90	80	120
200	225	20	45	60	95	90	135
225	250	25	50	65	100	100	150
250	280	25	55	75	110	110	165
280	315	30	60	80	120	120	180
315	355	30	65	90	135	135	200

Bearing Selection

Bearing Life

Bearing Tolerance

Bearing Arrangement

Preload and Rigidity

Lubrication

Limiting Speeds

Shaft and Housing Design

Bearing Handling

6

Lubrication

6-1 Purpose of Lubrication

The main purposes of rolling bearing lubrication is to reduce bearing friction and wear, and to prevent seizure. The appropriate lubrication methods and lubricating agents greatly influences rolling contact bearing performance and service life.

The following are the purposes of lubrication.

① Lubrication of friction surfaces

- 1) Reduce rolling friction on roller and raceway surfaces, and reduce sliding friction on roller and guide surfaces in roller bearings

- 2) Reduce sliding friction between the roller and the cage
- 3) Reduce sliding friction on cage and raceway ring guide surfaces
- ② Removal of friction-generated heat and heat transmitted from other mechanisms
- ③ Dust-proofing and rust prevention
- ④ Reduce stress concentration

- 1) Uniform distribution of stress on points or linear-contact rolling surfaces.
- 2) Buffering of impact load

6-2 Lubrication Methods

6.2.1 Oil Lubrication

① Forced lubrication (jet lubrication)

- Forced lubrication is used when cooling is required at relatively high speed rotation or under high ambient temperatures.
- Jet lubrication supplies vaporized lubricating oil using pressurized oil and a small nozzle, which has a cooling effect.
- The oil drain port must be larger than the oil supply port because agitation of oil that collects inside the housing increases heat generation and power loss. Particularly with jet lubrication, an oil drain port that is at least 10 times larger than the supply port opposite the nozzle is needed, and a pump should be used for forced draining.
- **Figure 6.1** shows an example of jet lubrication.

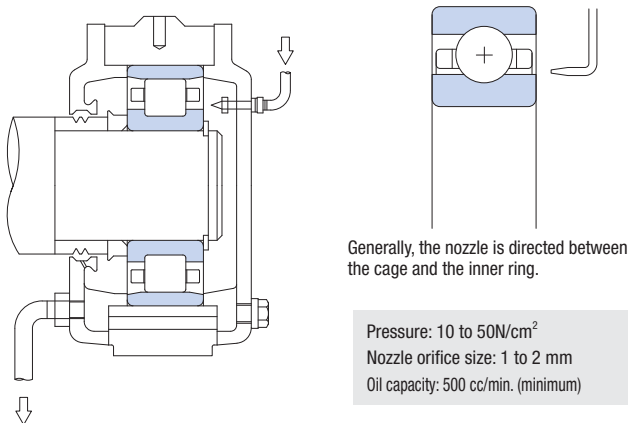

● **Figure 6.1** Jet Lubrication Example

② Vapor lubrication (oil mist lubrication)

- With this lubrication method, the bearing is air cooled and a small amount of oils required for lubrication is vaporized and sprayed onto the bearing. **Figure 6.2** shows an example of oil mist lubrication.
- Air sent to the mist generator via the pressure adjustor valve is mixed with oil, which is sprayed on the bearing.
- The nozzle can spray directly onto the bearing, or it can spray onto the bearing using the centrifugal force of the tapered part of a slinger installed on the axis (**Figure 6.3**).
- Generally, the mist pressure is 5 to 15 N/cm², with a few cc's of oil mixed with 10 to 50ℓ/parts of air every hour.
- Oil mist uses only a small amount of oil so it is suitable for high-speed operation with little bearing power loss, but since the specific heat of air is not large and it does not have great

heating effect, this type of lubrication is suitable for relatively low load applications.

③ Oil air lubrication

- With oil air lubrication, a small amount of lubricating oil is discharged by a measurement piston at fixed intervals, the lubricating oil is supplied by the mixing valve into compressed

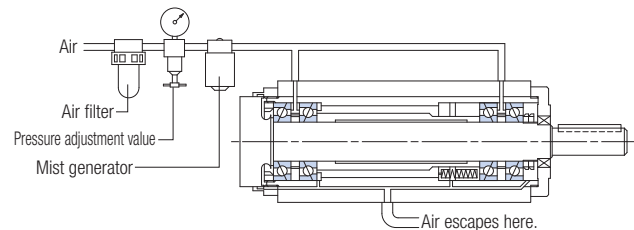

● **Figure 6.2** Example of Spindle Unit Using Vapor Lubrication

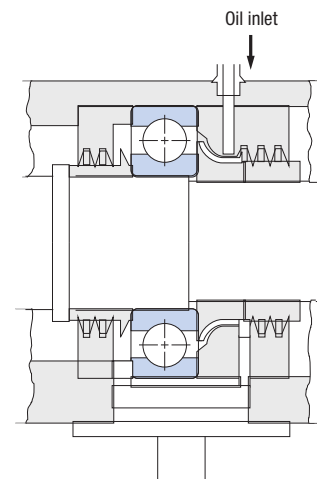

● **Figure 6.3** Example of Mist Oil Delivery by Slinger

air, and then supplied continually to rolling part of the bearing.

- Since a small and measured amount of new lubricating oil is constantly being supplied, this method is suitable for high-speed applications where little heat is generated.
- Oil air lubrication is more environmentally friendly because oil requirements are 1/10 that of vapor lubrication and the oil is delivered in the form of droplets rather than a mist.
- **Figure 6.4** shows an example of oil air lubrication.

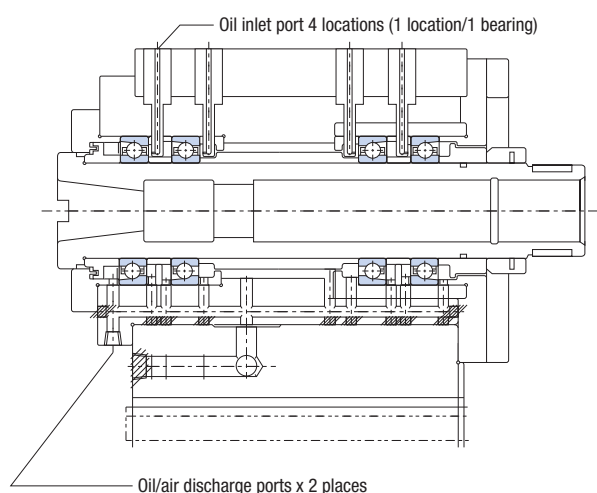

● **Figure 6.4** Example of Spindle Unit Using Oil Air Lubrication

6.2.2 Grease Lubrication

Note the following precautions whenever using grease lubrication.

- Select the proper grease. For examples of the main types of grease used for machine tool bearings, see **Table 6.1**.
- Make sure the grease replenishment amount and locations are correct. A greasing amount of 10 to 20% of the bearing internal space volume is recommended for high-speed roller bearings. Note, however, that 40 to 50% is recommended for a ball screw support bearing (open type).
- Over-greasing can result in very high temperatures and large power loss due to agitation. For information about internal space volume of bearings, see **Table 6.2** (page 24 to 25).
- For an example illustrating the difference in bearing temperature increase due to lubrication method, see **Figure 6.5**.

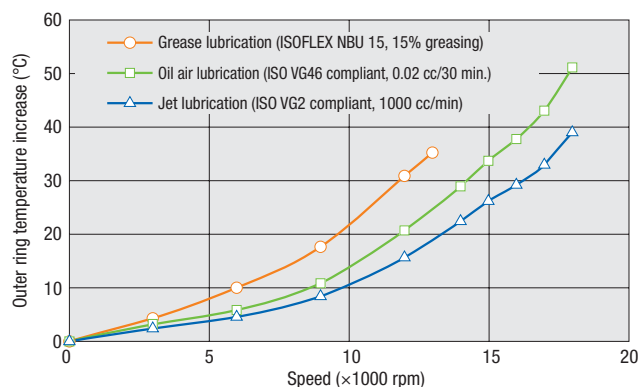

● **Figure 6.5** Comparison of Temperature Increase Caused by Different Lubrication Methods

● **Table 6.1** Main Grease Used for Machine Tool Bearings

Grease brand	Manufacturer	Base oil	Thickener	Recommended operation temperature range °C	Main applications
ISOFLEX NBU15	NOK KLUBER	Ester Oil	Barium composite	-40 ~ +130	Spindle bearing
ISOFLEX LDS18 Special A	NOK KLUBER	Ester Oil	Lithium	-60 ~ +130	Spindle bearing
Multemp LRL No. 3	Kyodo Yushi	Polyol Ester Oil	Lithium	-50 ~ +150	Spindle bearing
Alvania Grease S No. 2	Showa Shell Oil	Mineral Oil	Lithium	-25 ~ +120	Ball Screw Support Bearings
Multemp PS No. 2	Kyodo Yushi	Diester Oil + Hydrocarbon Oil	Lithium	-55 ~ +130	Ball Screw Support Bearings

Bearing Selection

Bearing Life

Bearing Tolerance

Bearing Arrangement

Preload and Rigidity

Lubrication

Limiting Speeds

Shaft and Housing Design

Bearing Handling

Lubrication

● **Table 6.2** Bearing Internal Space Volume

1 Internal space volume of angular contact ball bearings and cylindrical roller bearings

Unit: cc/each

Bore diameter number	Bore diameter (mm)	Series						
		7900C 7900AC	7000C 7000AC	7200C 7200AC	BNH000	TAH TBH	NN3000	NNU4900
00	10	0.44	0.9	1.2	—	—	—	—
01	12	0.49	1.0	1.7	—	—	—	—
02	15	0.68	1.4	2.2	—	—	—	—
03	17	0.68	1.7	3.0	—	—	—	—
04	20	1.5	2.9	4.7	—	—	—	—
05	25	1.9	3.4	5.3	—	—	3.6	—
06	30	2.2	4.8	8.2	—	—	5.9	—
07	35	3.0	6.4	10.3	5.6	—	7.5	—
08	40	5.2	7.8	13.0	7.2	—	9.5	—
09	45	5.7	10.2	15.4	9.0	—	12.8	—
10	50	6.2	10.7	18.6	9.7	8.0	13.8	—
11	55	—	15.9	25.9	14.0	12.0	19.6	—
12	60	—	17.0	33.2	15.0	13.0	20.7	—
13	65	—	18.2	39.1	16.0	14.0	21.8	—
14	70	—	27.7	45.2	22.0	19.0	30.4	—
15	75	—	28.7	49.4	23.0	20.0	32.9	—
16	80	—	32.1	59.0	30.0	27.0	46.3	—
17	85	—	36.3	73.5	31.0	28.0	47.8	—
18	90	—	49.2	93.1	40.0	38.0	62.9	—
19	95	—	53.0	117	42.0	40.0	64.5	—
20	100	—	55.1	135	43.0	41.0	67.3	49.5
21	105	—	—	—	54.0	52.0	91.8	57.9
22	110	—	—	—	66.0	65.0	114	59.6
24	120	—	—	—	71.0	70.0	126	86.4
26	130	—	—	—	108	105	178	102
28	140	—	—	—	114	111	195	114
30	150	—	—	—	138	139	235	195
32	160	—	—	—	174	167	288	199
34	170	—	—	—	227	225	374	209
36	180	—	—	—	—	—	508	281
38	190	—	—	—	—	—	530	296
40	200	—	—	—	—	—	684	448

2 Ball Screw Support Bearing (TAB Series) Internal Space Volume

Bearing no.	Internal space volume [cc/each]
15TAB04	3.8
17TAB04	3.8
20TAB04	3.8
25TAB06	4.8
30TAB06	4.8
35TAB07	5.8
40TAB07	5.8
40TAB09	14
45TAB07	6.5
45TAB10	15
50TAB10	16
55TAB10	16
55TAB12	19
60TAB12	19

3 Ball Screw Support Bearing (TAF Series) Internal Space Volume

Bearing no.	Internal space volume [cc/each]
25TAF06	9.3
30TAF07	14
35TAF09	26
40TAF09	26
40TAF11	45
45TAF11	45
50TAF11	45
60TAF13	71
60TAF17	150
80TAF17	150
100TAF21	282
120TAF03	473

6.2.3 Grease Life

Grease life is affected by operating temperature, grease type, rotation speed, load, and other factors. Grease life approximate estimates for a rolling contact bearing, which is used as a representative example, can be calculated using **Formula 5.1**.

$$\log L = -2.3 + \frac{2450}{273 + T} - 0.301 \times (S_G + S_N + S_W) \quad \text{(Formula 5.1)}$$

L : Grease life (hours)
 T : Bearing temperature (°C)
 S_G : Life reduction factor based on grease type

Grease type	S _G
Long life petroleum grease and silicon grease	0
Conventional petroleum grease	1.0
Diester and and low temperature grease	2.9

$$S_N = 0.864 \frac{d \cdot n}{(dn)_L}$$

S_N : Life reduction factor based on rotation speed
 d : Nominal bearing bore diameter (mm)
 n : Bearing speed (rpm)
 (dn)_L : Bearing type-specific speed factor

Bearing type	(dn) _L
Angular contact ball bearings	400,000
Cylindrical roller bearings	200,000

$$S_W = 2.714 \frac{n \cdot d \cdot w}{C^2}$$

S_W : Load-specific life reduction factor
 C : Basic dynamic load rating (N)
 w : Bearing load (N)

Bearing Selection

Bearing Life

Bearing Tolerance

Bearing Arrangement

Preload and Rigidity

Lubrication

Limiting Speeds

Shaft and Housing Design

Bearing Handling



Limiting Speeds

7-1 Limiting Speed Correction

Using a bearing at high speeds that exceed its limit generates frictional heat inside the bearing, which can cause temperatures to rise to levels that will not support bearing performance. The limit on the empirical rotation speed that avoids these problems is called the "rotation speed limit".

The rotation speed limit depends on the bearing type, dimensions, lubricating method, load, etc. The rotation speed limit of a contact seal bearing is limited by the circumferential speed of the contact sections of the seal and raceway ring. The dimension tables in this catalog show rotation speed limits for grease lubrication and oil

lubrication, but these values all assume light load, horizontal shaft operation, and proper lubrication.

Though normally two or more pre-loaded angular contact ball bearings are used, the rotation speed is limited in so it is necessary to multiply the speeds in the dimension tables by the correction factors shown in **Table 7.1**.

When using a bearing at 75% or more of its rotation speed limit, select the correct required grease type and amount or the correct lubrication oil and method.

● **Table 7.1** Correction Factors for Rotation Speed Limit of Duplex Bearings

No. of bearings in set	Extra-light preload (E)	Light preload (L)	Medium preload (M)	Heavy preload (H)
2 rows	0.83	0.78	0.63	0.54
3 rows	0.73	0.68	0.54	0.39
4 rows	0.78	0.73	0.59	0.44



Shaft and Housing Design

8-1 Shaft and Housing Fit

Appropriate inner ring and shaft fit, and outer ring and housing fit is required in order to get the most performance out of a bearing. Loose fit surfaces can result in rotation of the raceway rings on the shaft or in the housing.

This is called "creep." When it occurs creep can cause premature failure, vibration, and other trouble due to abnormal heat and wear, from debris getting into the bearing. An interference fit is a good way of preventing creep. For convenient installation the interference fit is on the inner ring and shaft or on the outer ring and housing (not

both).

However, this cannot be done under certain conditions so bearing fitting needs to be determined after carefully considering the relationship between the shaft and housing and other factors. Recommended fits for general operating conditions (inner ring rotation) of precision bearings used for machine tools are shown in **Tables 8.1 through 8.3.**

● **Table 8.1** Shafts and Recommended Fit

Unit: μm

Bearing type	Shaft diameter (mm)		Bearing accuracy class			
			Class 5		Class 4/Class 2	
	Over	Incl.	Desired fit	Shaft tolerance	Desired fit	Shaft tolerance
Angular contact ball bearings	10	18	0~2T	h4	0~2T	h3
	18	50	0~2.5T	h4	0~2.5T	h3
	50	80	0~3T	h4	0~3T	h3
	80	150	0~4T	js4	0~4T	js3
	150	200	0~5T	js4	0~5T	js3
Cylindrical roller bearings (cylindrical bore)	25	40	—	js4	—	js4
	40	140	—	k4	—	k3
	140	200	—	k4	—	k3
Main spindle thrust bearing	For all shaft diameters		0~6L	h4	0~6L	h4
Ball screw support bearings	For all shaft diameters		0~10L	h5	0~10L	h5

● **Table 8.2** Housings and Recommended Fit (Fixed Side)

Unit: μm

Bearing type	Housing bore diameter (mm)		Bearing accuracy class			
			Class 5		Class 4/Class 2	
	Over	incl.	Desired fit	Housing bore tolerance	Desired fit	Housing bore tolerance
Angular contact ball bearings	18	50	0~3L	JS4	0~3L	JS3
	50	120	0~4L	JS4	0~4L	JS3
	120	180	0~5L	JS4	0~5L	JS3
	180	250	0~6L	JS4	0~6L	JS3
Cylindrical roller bearings	Overall housing bore		± 0	K5	± 0	K5
Main spindle thrust bearing	Overall housing bore		30L~40L	K5	30L~40L	K5
Ball screw support bearings	Overall housing bore		10L~20L	H6	10L~20L	H6

● **Table 8.3** Housings and Recommended Fit (Free Side)

Unit: μm

Bearing type	Housing bore diameter (mm)		Bearing accuracy class			
			Class 5		Class 4/Class 2	
	Over	incl.	Desired fit	Housing bore tolerance	Desired fit	Housing bore tolerance
Angular contact ball bearings	18	50	6L~10L	H4	6L~10L	H3
	50	120	8L~13L	H4	8L~13L	H3
	120	180	12L~18L	H4	12L~18L	H3
	180	250	15L~22L	H4	15L~22L	H3
Cylindrical roller bearings	Overall housing bore		± 0	K5	± 0	K4
Ball screw support bearings	Overall housing bore		10L~20L	H6	10L~20L	H6

Note) In Tables 8.1 through 8.3, "L" following a value indicates loose or clearance fit, while "T" indicates tight or interference fit.

Bearing Selection

Bearing Life

Bearing Tolerance

Bearing Arrangement

Preload and Rigidity

Lubrication

Limiting Speeds

Shaft and Housing Design

Bearing Handling

Shaft and Housing Design

8-2 Recommended Accuracy for Shaft and Housing

In order to maintain mechanical performance of the main spindle of a machine tool, the accuracy of installation and of installed components must be equal to or higher than bearing accuracy.

The recommended bearing installation section accuracy and surface roughness are shown in **Tables 8.4 to 8.7**.

● **Table 8.4** Shaft Accuracy

Unit: μm

Accuracy item	Shaft diameter		Bearing accuracy class		
	Over	Incl.	Class 5	Class 4	Class 2
Roundness \bigcirc, a	—	10	1.3	0.8	0.5
	10	18	1.5	1.0	0.6
	18	30	2.0	1.3	0.8
	30	50	2.0	1.3	0.8
	50	80	2.5	1.5	1.0
	80	120	3.0	2.0	1.3
	120	180	4.0	2.5	1.8
Cylindricity \diamond, b	—	10	1.3	0.8	0.5
	10	18	1.5	1.0	0.6
	18	30	2.0	1.3	0.8
	30	50	2.0	1.3	0.8
	50	80	2.5	1.5	1.0
	80	120	3.0	2.0	1.3
	120	180	4.0	2.5	1.8
Vibration \nearrow, c	—	10	2.0	2.0	1.3
	10	18	2.5	2.5	1.5
	18	30	3.0	3.0	2.0
	30	50	3.5	3.5	2.0
	50	80	4.0	4.0	2.5
	80	120	5.0	5.0	3.0
	120	180	6.0	6.0	4.0
Concentricity \odot, d	—	10	4.0	4.0	2.5
	10	18	5.0	5.0	3.0
	18	30	6.0	6.0	4.0
	30	50	7.0	7.0	4.0
	50	80	8.0	8.0	5.0
	80	120	10.0	10.0	6.0
	120	180	12.0	12.0	8.0

● **Table 8.6** Housing Accuracy

Unit: μm

Accuracy item	Housing bore diameter		Bearing accuracy class		
	Over	Incl.	Class 5	Class 4	Class 2
Roundness \bigcirc, a_1	—	10	1.3	0.8	0.5
	10	18	1.5	1.0	0.6
	18	30	2.0	1.3	0.8
	30	50	2.0	1.3	0.8
	50	80	2.5	1.5	1.0
	80	120	3.0	2.0	1.3
	120	180	4.0	2.5	1.8
Cylindricity \diamond, b_1	—	10	1.3	0.8	0.5
	10	18	1.5	1.0	0.6
	18	30	2.0	1.3	0.8
	30	50	2.0	1.3	0.8
	50	80	2.5	1.5	1.0
	80	120	3.0	2.0	1.3
	120	180	4.0	2.5	1.8
Vibration \nearrow, c_1	—	10	2.0	2.0	1.3
	10	18	2.5	2.5	1.5
	18	30	3.0	3.0	2.0
	30	50	3.5	3.5	2.0
	50	80	4.0	4.0	2.5
	80	120	5.0	5.0	3.0
	120	180	6.0	6.0	4.0
Concentricity \odot, d_1	—	10	4.0	4.0	2.5
	10	18	5.0	5.0	3.0
	18	30	6.0	6.0	4.0
	30	50	7.0	7.0	4.0
	50	80	8.0	8.0	5.0
	80	120	10.0	10.0	6.0
	120	180	12.0	12.0	8.0

● **Table 8.5** Shaft Fitting Surface Roughness (Ra)

Shaft diameter d	Bearing accuracy class		
	Class 5	Class 4	Class 2
d ≤ 80mm	0.2	0.2	0.1
d > 80mm	0.4	0.4	0.2

● **Table 8.7** Housing Fitting Surface Roughness (Ra)

Housing bore diameter D	Bearing accuracy class		
	Class 5	Class 4	Class 2
D ≤ 80mm	0.4	0.4	0.2
80mm < D ≤ 250mm	0.8	0.8	0.4
D > 250mm	1.6	1.6	0.8

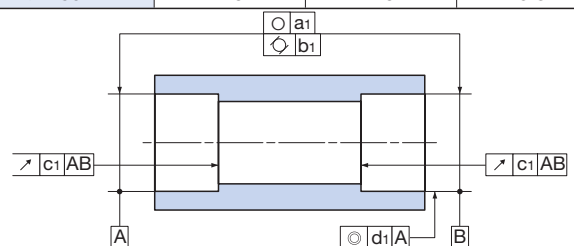
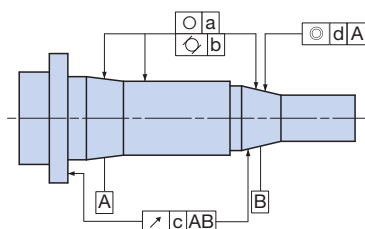

8-3 Chamfer Dimension Limits

● **Table 8.8** Chamfer Dimensions for Radial Bearings (Excluding Tapered Roller Bearings)

Unit: mm

Smallest permissible chamfer dimensions of inner and outer rings r (min) or r ₁ (min)	Nominal bearing bore diameter		Smallest permissible chamfer dimensions of inner and outer rings r (max) or r ₁ (max)		(Reference) Shaft or housing fillet radius ra
	Over	Incl.	Radial direction	Axial direction	Max
0.05	—	—	0.1	0.2	0.05
0.08	—	—	0.16	0.3	0.08
0.1	—	—	0.2	0.4	0.1
0.15	—	—	0.3	0.6	0.15
0.2	—	—	0.5	0.8	0.2
0.3	— 40	40	0.6 0.8	1 1	0.3
0.6	— 40	40	1 1.3	2 2	0.6
1	— 50	50	1.5 1.9	3 3	1
1.1	— 120	120	2 2.5	3.5 4	1
1.5	— 120	120	2.3 3	4 5	1.5
2	— 80 220	80 220	3 3.5 3.8	4.5 5 6	2
2.1	— 280	280	4 4.5	6.5 7	2
2.5	— 100 280	100 280	3.8 4.5 5	6 6 7	2
3	— 280	280	5 5.5	8 8	2.5
4	—	—	6.5	9	3
5	—	—	8	10	4
6	—	—	10	13	5
7.5	—	—	12.5	17	6
9.5	—	—	15	19	8
12	—	—	18	24	10
15	—	—	21	30	12
19	—	—	25	38	15

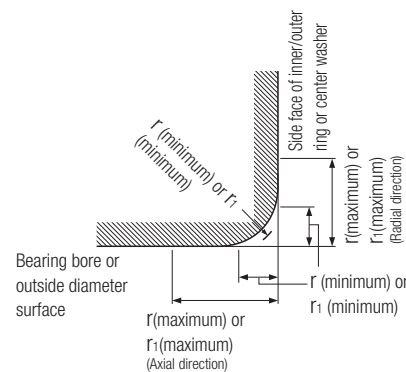

r: Chamfer dimensions of inner ring and outer ring
 r₁: Chamfer dimensions of inner ring and outer ring (front face etc.) or of center ring of thrust ball bearing

- Note
- ① Exact shape of chamfer is not specified. Limits fall within radial and axial minimum radius and maximum radius.
 - ② r (minimum) values in the axial direction of bearings with nominal bearing widths of 2 mm or less r (max) are the same as those in the radial direction.

Bearing Selection

Bearing Life

Bearing Tolerance

Bearing Arrangement

Preload and Rigidity

Lubrication

Limiting Speeds

Shaft and Housing Design

Bearing Handling

9

Bearing Handling

9-1 Storing and Transporting Bearings

Rolling contact bearings are precision components. It is important to handle them with care to avoid damage due to impact. Rolling contact bearings also are susceptible to dirt and rust, so care is required during storage and transport.

- When storing bearings, select a cool, dry location that is not exposed to direct sunlight or humidity.
- Do not leave bearings on the floor. Store them at a height of at least 30 cm, and avoid exposure to dust.

- First-in, first-out storage should always be used for bearing inventory management. Arrange bearings so those with the oldest packing date can be used first.
- Take care bearings being transported are not crushed or dropped, etc., protect them from damage and deformation due to impact, and ensure they do not become soiled due to broken packing materials.

9-2 Assembling Bearings

The quality of bearing installation influences precision, service life, performance, and other factors, so care is required. The following is the procedure for assembly work.

- ① Shaft and housing inspection
- ② Unpacking and cleaning
- ③ Assembly
- ④ Post assembly check

9.2.1 Shaft and Housing Inspection

- Clean the shaft and housing thoroughly and remove any dirt and debris. Also, confirm there are no burrs.
- Confirm that the shaft and housing are finished in accordance with the drawings, and check and record dimensions, shoulder squareness, and the corner radius. As shown in **Figure 9.1**, measure the shaft diameter and housing bore at two locations in the axial direction and four locations radially.

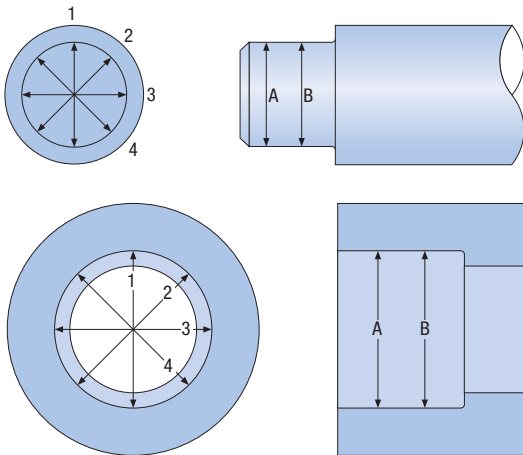

● **Figure 9.1** Shaft Diameter and Housing Diameter Measurement Locations

9.2.2 Unpacking and Cleaning

- Do not unpack a bearing until just before you are ready to use it. Be sure to wear vinyl gloves when unpacking a bearing. Unpacking a bearing with bare hands or while wearing fabric gloves creates the risk of rust or lint intrusion.
- Apply anti-rust oil to the surface of the unpacked bearing. Wash the bearing with white kerosene. For washing, prepare either a filtered shower or two containers with raised wire mesh bottoms, one for basic washing and one for finish washing.

- After washing, shake the oil from the bearing and then cover it. Do not rotate a bearing that has been degreased.

9.2.3 Assembly

Generally the majority of bearings assembled into machine tools have interference shaft fits and loose housing fits. The methods used for mounting bearings to shafts are the shrink and press fits.

Shrink fits

With this mounting method, the bearing is heated until it expands larger than the shaft and the inner ring can be slipped onto the shaft. An electromagnetic heater with degausser (**Figure 9.2**) avoids undue stress to the inner ring, while an oven helps to shorten process time. Heating temperature must be no greater than 120°C. Temperatures greater than 120°C can decrease bearing hardness and shortens its service life.

After a heated bearing is installed on a shaft, it contracts axially as it cools, which can cause a gap between the inner ring and shaft shoulder (**Figure 9.3**), so positioning is achieved using a nut, etc.

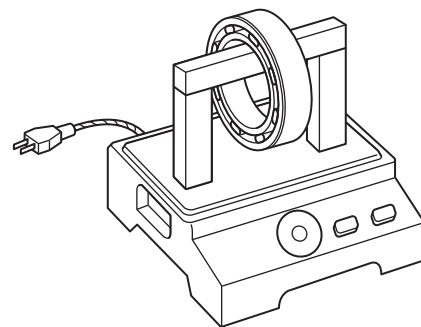

● **Figure 9.2** Induction Heater



● **Figure 9.3** Shaft Shoulder Gap After Cooling

Press fits

With this method, a tool is placed on the inner ring side surface and a jack or press is used to press fit (Figure 9.4). When press fitting the inner ring on a shaft do not apply force to the outer ring or cage. In the case of an angular contact ball bearing, application of force in the opposite direction of the contact angle direction should be avoided because it will damage the raceway shoulder (Figure 9.5).

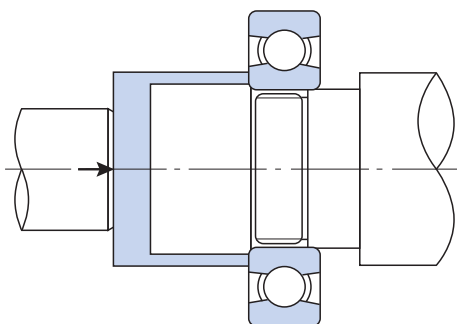

● Figure 9.4 Inner Ring Press Fitting

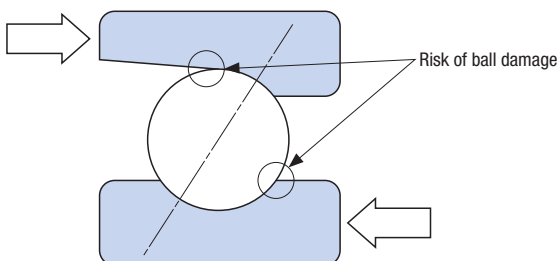

● Figure 9.5 Angular Contact Ball Bearing Assembly Direction

Reference: Maximum radial run-out locations

The maximum radial run-out locations of the inner ring and outer ring are indicated by "○" marks on the ring face. Axial run-out can be minimized by aligning the minimum radial run-out location of the axis with the "○" mark on the inner ring. The outer ring also should be assembled so its "○" mark is aligned with the minimum run-out locations of the housing.

Note that there is no relationship between the outside ring "○" mark position and the outside diameter "<" mounting mark position.

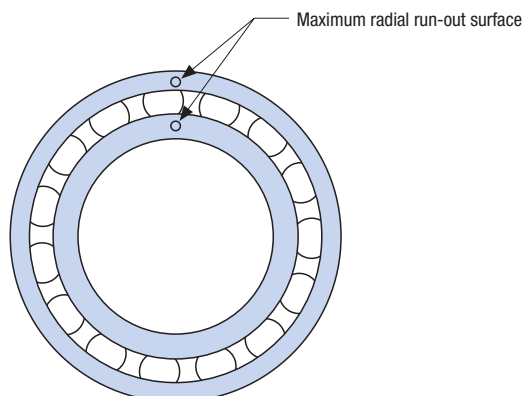

● Figure 9.6 Maximum Radial Run-out Locations

Reference: Press fit force and removal force

Though the force required to press fit a bearing inner ring to and removing it from the shaft depends on interference amounts and the shaft surface finish, general values can be obtained using Formula 9.1.

$$K_a = f_k \cdot \Delta d_e \cdot B \cdot \left(1 - \left\{ \frac{d}{d_i} \right\}^2\right) \quad \text{--- (Formula 9.1)}$$

- K_a : Press fit force (removal force) (kN)
- f_k : Installation/removal condition coefficient (Table 9.1)
- Δd_e : Effective interference (mm)
- B : Nominal inner ring width (mm)
- d : Nominal bearing bore diameter (mm)
- d_i : Inner ring mean outside diameter (mm)
- Cylindrical roller bearing
d_i = (D + 3d) / 4
- Other bearings
d_i = (3D + 7d) / 10
- Here, D = Nominal bearing outside diameter (mm)

● Table 9.1 Installation/Removal Condition Coefficient

Conditions	f _k (mean value)
Inner ring press fit to cylindrical solid shaft	39
Inner ring removal from cylindrical solid shaft	59

Note) Values when shaft bore and shaft are thinly coated with oil.

Bearing Selection

Bearing Life

Bearing Tolerance

Bearing Arrangement

Preload and Rigidity

Lubrication

Limiting Speeds

Shaft and Housing Design

Bearing Handling

Bearing Handling

Mounting on a shaft

Normally a shaft nut is used to secure the inner ring of the bearing to the shaft.

It is necessary to ensure that the shaft nut side surface is at the proper angle relative to the thread. If the surfaces are not square tightening of the shaft nut can result in bending of the shaft.

Also, adjustment of the shaft nut is required when tightening it because of edge contact due to a gap in the mating surface between the shaft nut and the shaft.

Tightening with the shaft nut makes it possible to apply a specific tightening force by controlling the tightening torque. Though there is a discrepancy in the relationship between shaft nut tightening torque and the tightening force due to the accuracy and roughness of each threaded portion, it can be expressed as **Formula 9.2**.

The recommended mounting force for each bearing bore is shown in **Table 9.2**.

$$F \approx \frac{M_n}{\frac{d_2}{2} \tan(\beta + \rho) + \frac{d_n}{2} \cdot \mu_m} \quad \text{(Formula 9.2)}$$

- F : Tightening force (N)
- M_n : Tightening torque (N·mm)
- d₂ : Thread nominal diameter (mm)
- β : Lead angle

$$\tan \beta = \frac{P}{\pi d_2}$$

- P : Pitch (mm)
- ρ : Thread surface friction angle

$$\tan \rho = \frac{\mu}{\cos \alpha}$$

- α : Half-angle of thread
- d_n : Mean diameter of nut bearing surface (mm)
- μ_m : Coefficient of friction of nut bearing surface (≈ 0.15)
- μ : Coefficient of friction of thread surface (≈ 0.15)

● **Table 9.2** Recommended Shaft Nut Tightening Force Values

Nominal bearing bore diameter (mm)	Shaft nut tightening force (N)	Nominal bearing bore diameter (mm)	Shaft nut tightening force (N)
10	1500	80	19600
12	2500	85	19600
15	2500	90	19600
17	2500	95	19600
20	4900	100	19600
25	4900	105	19600
30	4900	110	19600
35	4900	120	19600
40	9800	130	19600
45	9800	140	29400
50	9800	150	29400
55	14700	160	29400
60	14700	170	29400
65	14700	180	29400
70	14700	190	29400
75	14700	200	29400

Mounting on a housing

In order to secure the outer ring of a bearing in the axial direction, clearing normally is maintained between the press-fit cover and housing and a bolt is used for tightening. Caution is required because outer ring misalignment and deformation can occur bolts are not tightened correctly or uniformly (**Figure 9.7**).

Generally an outside ring clearance reduction gap Δ of 0.010 to 0.020 is recommended. Recommended clearance reduction gap values for a face-to-face ball support bearing (TAB Series, TAF Series) are shown in **Tables 9.3 and 9.4**.

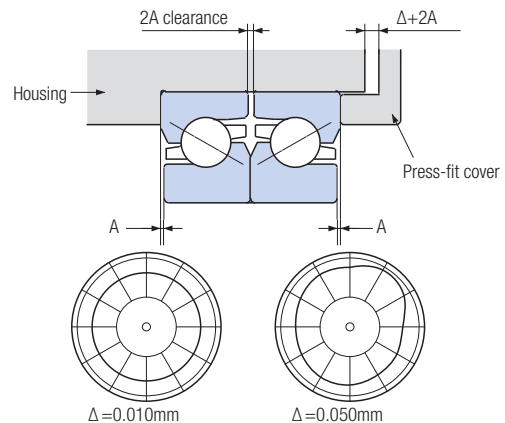

● **Figure 9.7** Example of Raceway Deflection Depending on Outer Ring Clearance Reduction Gap

● **Table 9.3** Recommended Clearance Reduction Gap Values for Ball Screw Support Bearings (TAB Series)

Bearing no.	External ring clearance reduction gap Δ (mm)
15TAB04 DF	0.010 ~ 0.030
17TAB04 DF	
20TAB04 DF	
25TAB06 DF	0.010 ~ 0.040
30TAB06 DF	
35TAB07 DF	
40TAB07 DF	
40TAB09 DF	
45TAB07 DF	0.020 ~ 0.050
45TAB10 DF	
50TAB10 DF	
55TAB10 DF	
55TAB12 DF	0.020 ~ 0.060
60TAB12 DF	

● **Table 9.4** Recommended Clearance Reduction Gap Values for Ball Screw Support Bearings (TAF Series)

Bearing no.	External ring clearance reduction gap Δ (mm)
25TAF06 DF	0.020
30TAF07 DF	0.030
35TAF09 DF	
40TAF09 DF	
40TAF11 DF	0.040
45TAF11 DF	
50TAF11 DF	
60TAF13 DF	
60TAF17 DF	0.050
100TAF21 DF	
120TAF03 DF	

Tapered bore cylindrical roller bearing clearance adjustment

The internal clearance of a tapered bore cylindrical roller bearing can be adjusted by the spacer width using the procedure below.

- ① Check the shaft taper. Coat the taper with a thin layer of bluing; 80% or more contact is required.
- ② Lightly place the inner sub-unit onto the shaft taper (Figure 9.8).
- ④ Place the outer ring and fix the shaft horizontally.
- ⑥ Touch the center the outer ring with a dual gauge probe.
- ⑦ Pressing down on the outer ring from above, rotate it left and right a few times so it fits well, and then zero set the dial gauge.
- ⑧ Push the outer ring straight up 180° from its position of symmetry (directly below), and rotate it slightly left and right to take a reading of its maximum value (Figure 9.9).
- ⑨ Change the position of the shaft at steps of approximately 30°, measure the axial displacement, and calculate the average of the readings as the value of D R.
- ⑩ Use a block gauge to measure the length to the inner ring edges surface and shaft shoulder (Figure 9.10).
- ⑪ Change the position and use the average of five or six locations as the value for L'.
- ⑫ Use Formula 9.3 to determine the wide dimension of the required spacer.

$$L = L' - 12(\Delta R - \Delta - \lambda e \cdot \delta) \quad \text{————— (Formula 9.3)}$$

- L' : Average spacer width obtained in step ⑪
- ΔR : Measured radial clearance
- Δ : Desired post-assembly radial clearance
- λe : External ring contraction ratio

$$\lambda e = \frac{D_e}{D} - \frac{1 - \left(\frac{D}{D_h}\right)^2}{1 - \left(\frac{D_e}{D_h}\right)^2}$$

- D : Inner ring outside diameter (mm)
- D_e : Inner ring bore (mm)
- D_h : Housing bore (mm)
- δ : Outer ring interference

- ⑬ Correct the spacer width dimension.
- ⑭ Remove the inner sub-unit from the shaft. This time avoid striking the inner ring with strong force. Use of a special removal tool to make ring removal easy.
- ⑮ Install the spacer and bearing onto the shaft.
- ⑯ Again, measure the radial clearance and confirm that the desired radial clearance is provided (Figure 9.11).

9.2.4 Post Assembly Check

Use the procedure under "5-3 Measuring Preload" (page 14) to confirm that the prescribed preload is being applied.

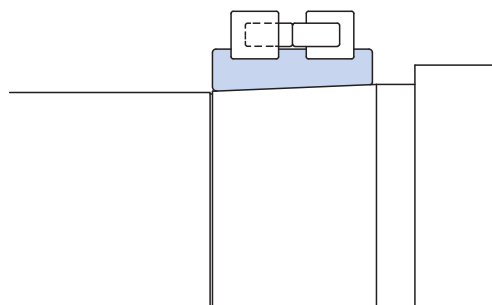

● Figure 9.8 Inner Sub-unit Temporary Tightening

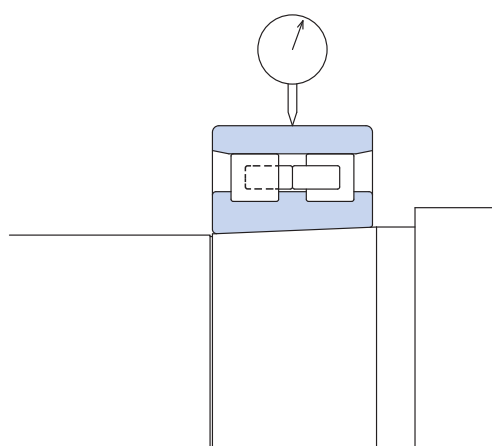

● Figure 9.9 Radial Clearance Measurement

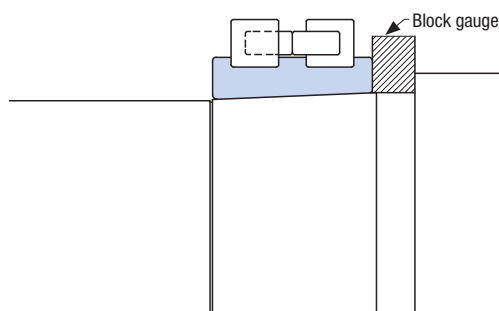

● Figure 9.10 Spacer Temporary Width Dimension Measurement

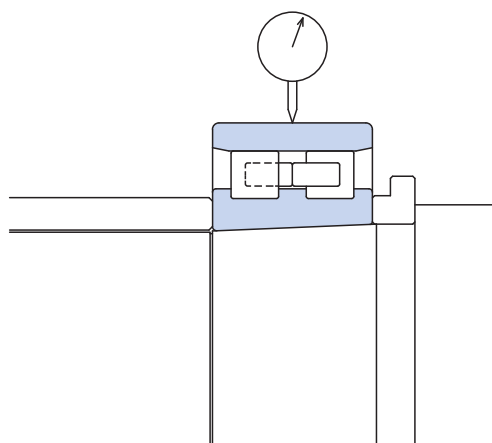

● Figure 9.11 Final Assembly Radial Clearance Check

- Bearing Selection
- Bearing Life
- Bearing Tolerance
- Bearing Arrangement
- Preload and Rigidity
- Lubrication
- Limiting Speeds
- Shaft and Housing Design
- Bearing Handling

Bearing Handling

9-3 Running Test

After installing bearings, a test run is performed to confirm that operation is normal. Particularly when using grease lubrication the grease must be allowed to get inside the bearing, and so sufficient break-in running is required.

The following is the general running test procedure.

- ① Check to make sure there is no gap between the shaft and housing or the cover or that all the gaps are uniform.
- ② First rotate manually any rotatable mechanisms and check for abnormal noise and sticking.
- ③ For large mechanisms that cannot be rotated manually, start at a speed that is as low as possible then do the same checks as step
 - ② while coasting.
 - ④ If no abnormalities are discovered during the first three steps above, gradually increase speed up to normal operating speed while confirming that the rise in temperature is within normal conditions.
 - ⑤ For long term operation, check for bolt and nut looseness, oil and grease leaks, and abnormal noise. If possible, after completing the test run drain the lubricant and check for the presence of foreign matter.
 - ⑥ Actual operation can be started after completing the run in test.

9-4 Removing Bearings

Though the main reasons for removing bearings is periodic maintenance and mechanical breakdown, it also should be used as an opportunity to check the current status of a machine and to use what is learned for improvements, etc. Particularly in the case of malfunction, the key reasons for the breakdown usually can be found after disassembly. Because of this, the following points should be checked when removing bearings.

- ① Problems with bearing installation
 - ② Insufficient lubricating oil or grease, and the amount of contaminants present (Collect samples.)
 - ③ Inner ring and outer ring fit
 - ④ Bearing trouble
- The following items also need to be settled before starting bearing removal.
- ① Bearing removal method
 - ② Fitting conditions
 - ③ Tools required for removal

Dimension Tables

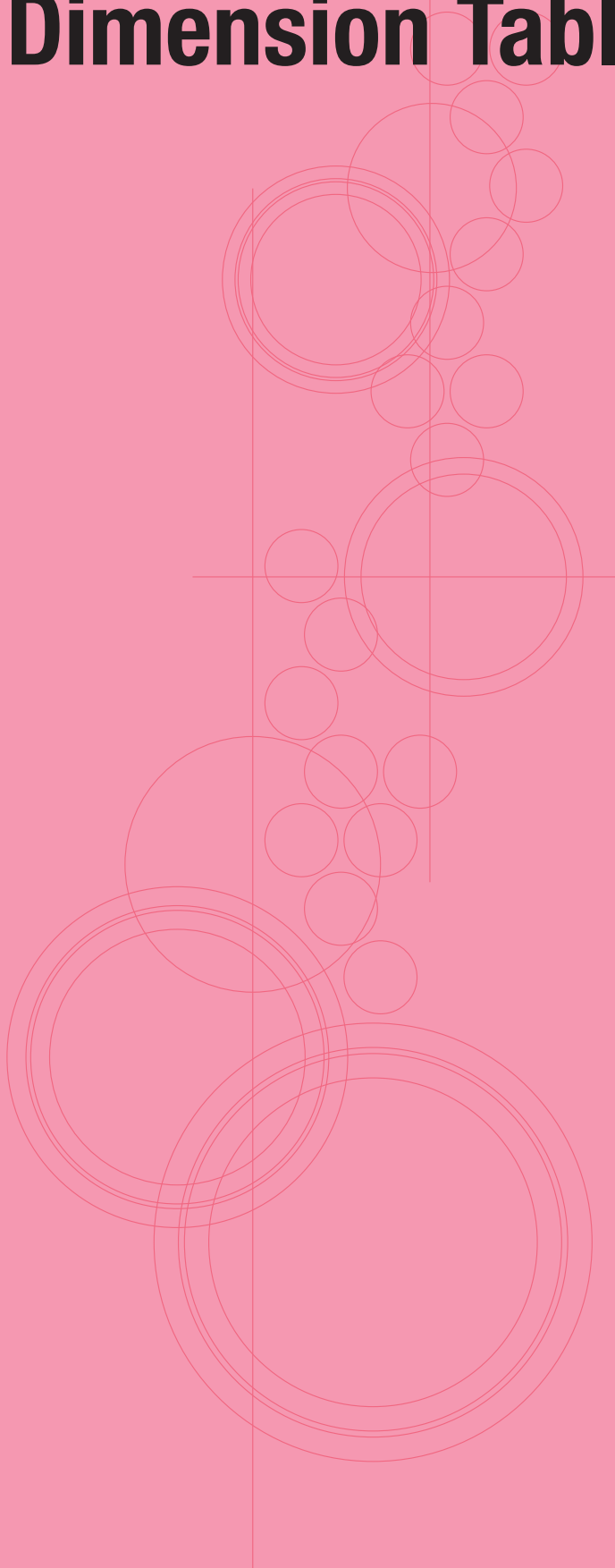

Dimension Tables

Types
and
Designs

7900
7000
7200

BNH

TAH
TBH

NN3000
NNU4900

XRN
XRG

TAB
TAF

Precision Rolling Bearings

Angular Contact Ball Bearings
High-speed Angular Contact Ball Bearings
Thrust Load Angular Contact Ball Bearings
Multiple-row Cylindrical Roller Bearings
Cross Tapered Roller Bearings
Ball Screw Support Bearings



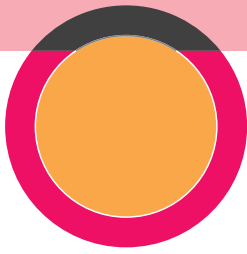

Precision Rolling Bearing Types and Designs

Type	Cross section	Bearing series	Contact angle	Description
Angular contact ball bearings		7900C	15°	<ul style="list-style-type: none"> ● Balls and the inner ring and outer ring raceways are designed for contact in a specific contact angle, which means this type of bearing is suitable for composite loads (axial load and radial load). ● The contact angle means that axial force components are generated when a radial load is applied, so these bearings are normally used in pairs at either end of a shaft. ● A contact angle of 15° is best for high speed, while a contact angle of 25° is better for axial loads.
		7900AC	25°	
		7000C	15°	
		7000AC	25°	
		7200C	15°	
		7200AC	25°	
High-speed angular contact ball bearings		BNH	15°	<ul style="list-style-type: none"> ● Since ball slipping is reduced by the gyro-moment at high-speeds, the ball diameter of this type of bearing is smaller than that of a standard angular contact ball bearing. ● This type of bearing is dimensionally interchangeable with the 7000 Series, and can be used for their replacement.
Thrust load angular contact ball bearings		TAH	30°	<ul style="list-style-type: none"> ● The contact angle of this type is smaller than that of the previous TAD Series (double-direction thrust angular contact ball bearings), for less gyro-moment induced ball sliding and lower temperature. ● Can be used to replace TAD Series bearings.
		TBH	40°	
NN type multiple-row cylindrical roller bearings		NN3000	—	<ul style="list-style-type: none"> ● A large number of rollers (cylindrical) for high rigidity. ● Tapered bore allows adjustment of the internal clearance. ● Oil groove and oil hole in the center of the outer ring width are also available.
NNU type multiple-row cylindrical roller bearings		NNU4900	—	
Cross tapered roller bearings		XRN XRG	—	<ul style="list-style-type: none"> ● Designed as an alternate to tapered roller bearings, this series provides high axial load and moment load rigidity. ● Rollers have rotational and orbital centers for smooth rotation.
Ball screw support bearings		TAB	60°	<ul style="list-style-type: none"> ● Mainly used in machine tool ball screw support applications. ● Open type and sealed type (contact type, non-contact type) available.
		TAF	50° (55°)	



Angular Contact Ball Bearings

Standard Type

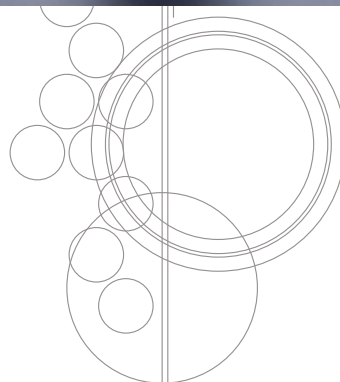

Nomenclature of Bearing Numbers

SH6- 7 2 08 C Y DU /GL P4

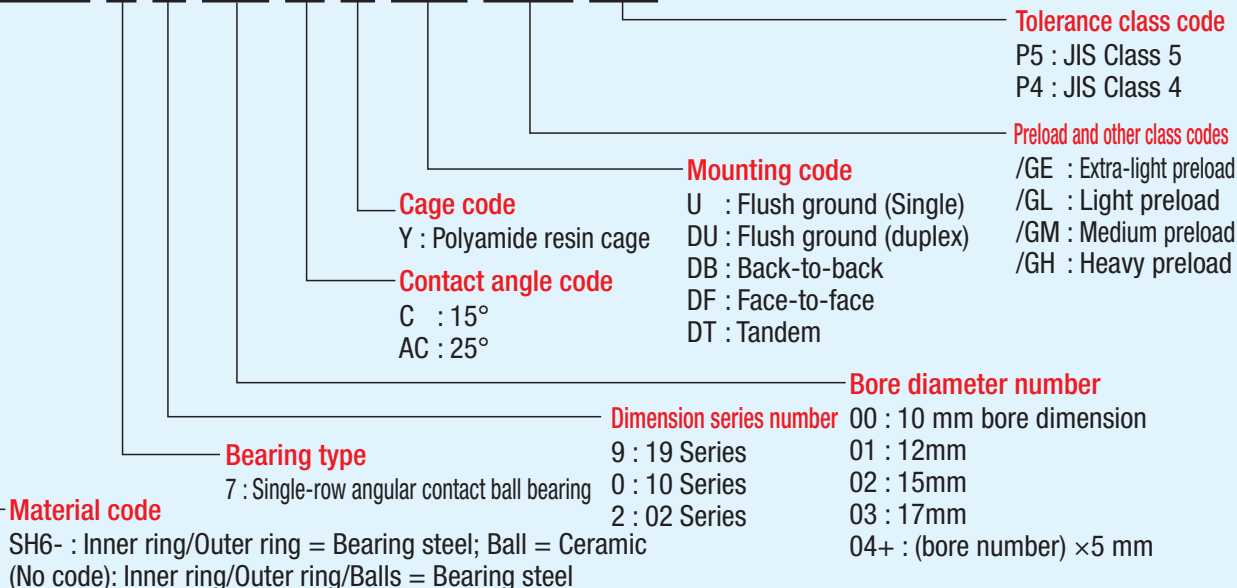

Features

- With angular contact ball bearings, the balls and the inner ring and outer ring raceways form a specific angle of contact. When used in a single configuration, axial load is limited to a single direction, this type of bearing is suitable for bearing composite loads made up of axial and radial loads.
- Since this type of bearing has a contact angle, axial components are generated when a radial load is applied. Because of this, this type of bearing is normally used in pairs at either end of a shaft.
- Ceramic ball type also available.

Contact Angle

Two contact angles are available: 15° and 25°. 15° is for high-speed applications. 25° is for applications requiring high axial rigidity.

Cage

A ball guide polyamide cage is provided as standard. The polyamide cage should be used under temperatures lower than 120°.

Dimensional Accuracy, Rotational Accuracy

Conforms to JIS Class 5 or Class 4. See page 7 for details.

Preload

- Four types of standard preload settings are available. Use the nearby table to select the preload that meets your criteria.
- See page 16 through 18 for standard preloads available for each series and size.

Preload Selection Criteria

Preload code	Selection criteria
E (extra-light preload)	Prevents mechanical vibration and increases accuracy.
L (light preload)	Provides rigidity at high-speed (dmn value = 500,000) operation.
M (medium preload)	Provides higher than light preload rigidity at standard-speed operation.
H (heavy preload)	Provides maximum rigidity at low-speed operation.

Mounting

See page 12 and 13 for multiple-row arrangements.

Ceramic Ball Types

Bearings with ceramic balls that are less dense than bearing steel balls also are available for lower centrifugal force when balls rotate at high speeds.

- The characteristics of ceramic and bearing steel are shown in the table below.
- The bearing number of a bearing that uses ceramic balls starts with "SH6-".
- Preload and axial rigidity is approximately 1.2 times that of bearing steel type bearings.

Comparison of Ceramic and Bearing Steel Characteristics

Features	Unit	Ceramic (Si ₃ N ₄)	Bearing steels (SUJ2)
Heat resistance	°C	800	180
Density	g/cc	3.2	7.8
Linear expansion coefficient	1/°C	3.2×10 ⁻⁶	12.5×10 ⁻⁶
Hardness	Hv	1400~1700	700~800
Longitudinal elastic coefficient	GPa	314	206
Poisson's ratio	—	0.26	0.30
Corrosion resistance	—	Good	No good
Magnetism	—	Non-magnetic substance	Strongly magnetic substance
Conductivity	—	Insulator	Conductor
Crystal chemical bonding	—	Covalent	Metallic

Angular Contact Ball Bearings

7900C Series Contact angle $\alpha = 15^\circ$

7900AC Series Contact angle $\alpha = 25^\circ$

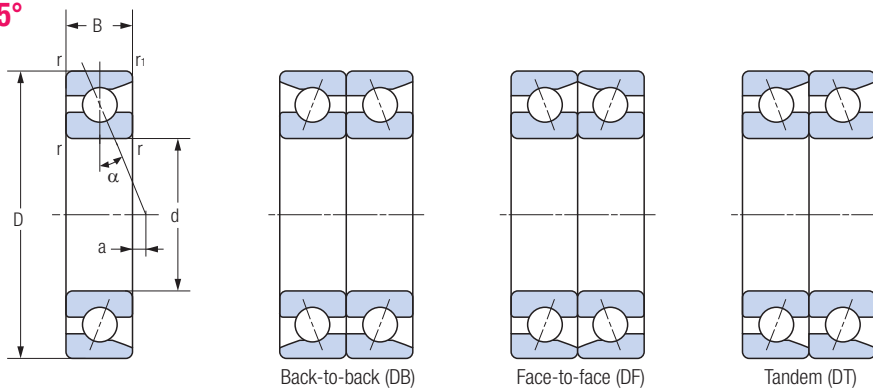

Bearing no.	Boundary dimensions (mm)					Load center a (mm)	Basic dynamic load rating Cr (kN)	Basic static load rating Cor (kN)
	d	D	B	r (Min)	r1 (Min)			
7900C	10	22	6	0.3	0.15	-0.9	3.00	1.52
7900AC	10	22	6	0.3	0.15	0.7	2.88	1.45
7901C	12	24	6	0.3	0.15	-0.6	3.20	1.72
7901AC	12	24	6	0.3	0.15	1.2	3.05	1.63
7902C	15	28	7	0.3	0.15	-0.6	4.75	2.64
7902AC	15	28	7	0.3	0.15	1.5	4.55	2.53
7903C	17	30	7	0.3	0.15	-0.3	5.00	2.95
7903AC	17	30	7	0.3	0.15	2.1	4.75	2.82
7904C	20	37	9	0.3	0.15	-0.7	7.30	4.55
7904AC	20	37	9	0.3	0.15	2.1	6.95	4.35
7905C	25	42	9	0.3	0.15	0.1	7.80	5.45
7905AC	25	42	9	0.3	0.15	3.5	7.40	5.15
7906C	30	47	9	0.3	0.15	0.7	8.30	6.25
7906AC	30	47	9	0.3	0.15	4.5	7.85	5.95
7907C	35	55	10	0.6	0.3	1.0	12.5	9.65
7907AC	35	55	10	0.6	0.3	5.5	11.9	9.20
7908C	40	62	12	0.6	0.3	0.8	15.7	12.4
7908AC	40	62	12	0.6	0.3	5.9	14.9	11.8
7909C	45	68	12	0.6	0.3	1.6	16.6	14.1
7909AC	45	68	12	0.6	0.3	7.2	15.7	13.3
7910C	50	72	12	0.6	0.3	2.2	17.7	15.5
7910AC	50	72	12	0.6	0.3	8.2	16.4	14.9

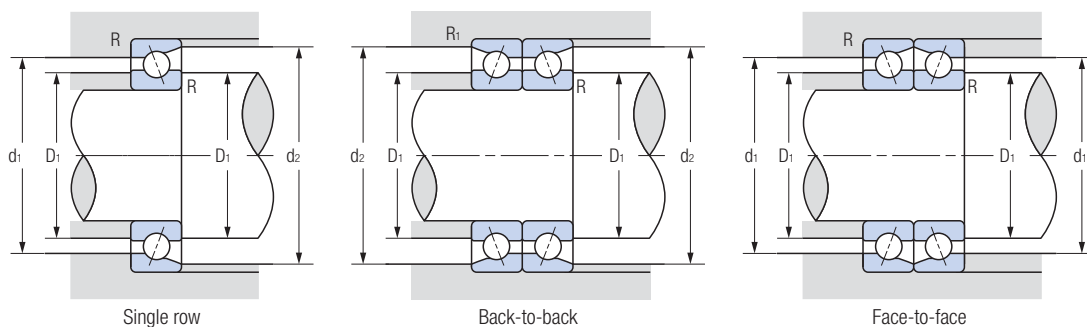

Dimension Tables

Rotation speed limit (rpm)		Corner radius (mm)					Mass (kg) (Reference)	Bearing no.
Grease lubrication	Oil lubrication	D_1 (Min)	d_1 (Max)	d_2 (Max)	R (Max)	R_1 (Max)		
73000	100000	12.5	19.5	20.8	0.3	0.15	0.008	7900C
63500	85000	12.5	19.5	20.8	0.3	0.15	0.008	7900AC
64800	88800	14.5	21.5	22.8	0.3	0.15	0.010	7901C
56400	75500	14.5	21.5	22.8	0.3	0.15	0.010	7901AC
54300	74400	17.5	25.5	26.8	0.3	0.15	0.015	7902C
47200	63200	17.5	25.5	26.8	0.3	0.15	0.015	7902AC
49700	68000	19.5	27.5	28.8	0.3	0.15	0.016	7903C
43200	57800	19.5	27.5	28.8	0.3	0.15	0.016	7903AC
41000	56100	22.5	34.5	35.8	0.3	0.15	0.035	7904C
35600	47700	22.5	34.5	35.8	0.3	0.15	0.035	7904AC
34800	47700	27.5	39.5	40.8	0.3	0.15	0.041	7905C
30300	40600	27.5	39.5	40.8	0.3	0.15	0.041	7905AC
30300	41500	32.5	44.5	45.8	0.3	0.15	0.046	7906C
26300	35300	32.5	44.5	45.8	0.3	0.15	0.046	7906AC
25900	35500	39.5	50.5	52.5	0.6	0.3	0.074	7907C
22500	30200	39.5	50.5	52.5	0.6	0.3	0.074	7907AC
22900	31300	44.5	57.5	59.5	0.6	0.3	0.107	7908C
19900	26600	44.5	57.5	59.5	0.6	0.3	0.107	7908AC
20600	28300	49.5	63.5	65.5	0.6	0.3	0.127	7909C
18000	24000	49.5	63.5	65.5	0.6	0.3	0.127	7909AC
19100	26200	54.5	67.5	69.5	0.6	0.3	0.128	7910C
16600	22300	54.5	67.5	69.5	0.6	0.3	0.128	7910AC

Types and Designs

7900
7000
7200

BNH

TAH
TBH

NN3000
NNU4900

XRN
XRG

TAB
TAF

Angular Contact Ball Bearings

7000C Series Contact angle $\alpha = 15^\circ$

7000AC Series Contact angle $\alpha = 25^\circ$

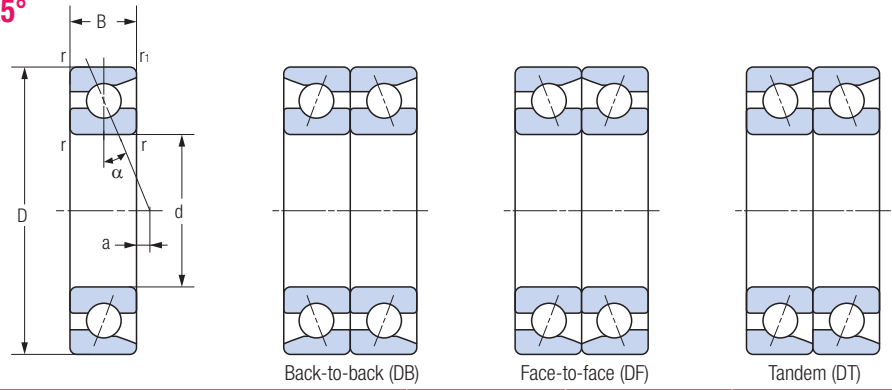

Bearing no.	Boundary dimensions (mm)					Load center a (mm)	Basic dynamic load rating Cr (kN)	Basic static load rating Cor (kN)
	d	D	B	r (Min)	r1 (Min)			
7000C	10	26	8	0.3	0.15	-1.9	5.35	2.50
7000AC	10	26	8	0.3	0.15	0.2	5.15	2.41
7001C	12	28	8	0.3	0.15	-1.7	5.80	2.91
7001AC	12	28	8	0.3	0.15	0.7	5.60	2.79
7002C	15	32	9	0.3	0.15	-1.8	6.65	3.70
7002AC	15	32	9	0.3	0.15	1.0	6.30	3.55
7003C	17	35	10	0.3	0.15	-2.0	7.00	4.15
7003AC	17	35	10	0.3	0.15	1.1	6.65	3.95
7004C	20	42	12	0.6	0.3	-2.4	11.2	6.60
7004AC	20	42	12	0.6	0.3	1.2	10.6	6.25
7005C	25	47	12	0.6	0.3	-1.8	12.9	8.65
7005AC	25	47	12	0.6	0.3	2.4	11.7	7.60
7006C	30	55	13	1	0.6	-1.6	16.0	11.1
7006AC	30	55	13	1	0.6	3.4	15.1	10.5
7007C	35	62	14	1	0.6	-1.4	19.3	13.7
7007AC	35	62	14	1	0.6	4.3	18.2	13.0
7008C	40	68	15	1	0.6	-1.3	20.7	16.0
7008AC	40	68	15	1	0.6	5.1	19.5	15.1
7009C	45	75	16	1	0.6	-1.1	24.6	19.4
7009AC	45	75	16	1	0.6	6.0	23.1	18.3
7010C	50	80	16	1	0.6	-0.5	26.2	22.0
7010AC	50	80	16	1	0.6	7.2	23.7	19.7
7011C	55	90	18	1.1	0.6	-0.6	34.5	28.8
7011AC	55	90	18	1.1	0.6	7.9	31.0	25.6
7012C	60	95	18	1.1	0.6	-0.1	35.5	30.5
7012AC	60	95	18	1.1	0.6	9.1	32.0	27.6
7013C	65	100	18	1.1	0.6	0.5	37.5	34.5
7013AC	65	100	18	1.1	0.6	10.2	34.0	31.0
7014C	70	110	20	1.1	0.6	0.4	47.0	43.0
7014AC	70	110	20	1.1	0.6	11.0	44.5	41.0
7015C	75	115	20	1.1	0.6	1.0	48.5	46.0
7015AC	75	115	20	1.1	0.6	12.2	45.5	43.0
7016C	80	125	22	1.1	0.6	0.8	59.0	55.5
7016AC	80	125	22	1.1	0.6	12.9	55.5	52.5
7017C	85	130	22	1.1	0.6	1.4	60.5	59.0
7017AC	85	130	22	1.1	0.6	14.1	57.0	55.5
7018C	90	140	24	1.5	1	1.3	72.0	69.5
7018AC	90	140	24	1.5	1	14.8	68.0	65.5
7019C	95	145	24	1.5	1	1.9	74.0	73.5
7019AC	95	145	24	1.5	1	16.0	69.5	69.5
7020C	100	150	24	1.5	1	2.4	76.0	77.5
7020AC	100	150	24	1.5	1	17.2	71.0	73.0

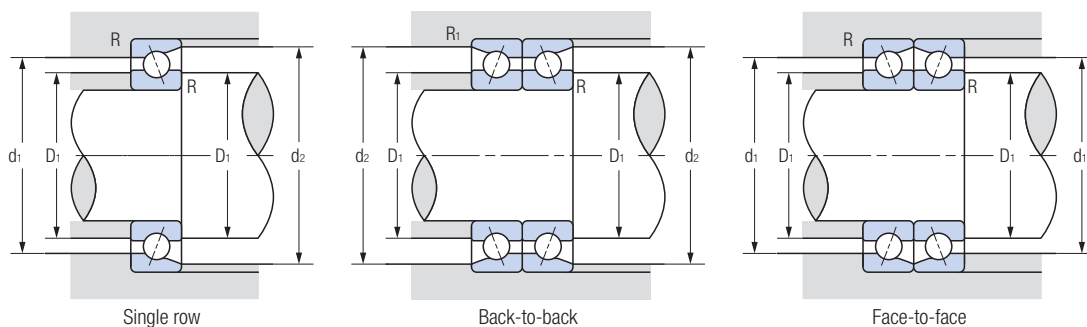

Rotation speed limit (rpm)		Corner radius (mm)					Mass (kg) (Reference)	Bearing no.
Grease lubrication	Oil lubrication	D_1 (Min)	d_1 (Max)	d_2 (Max)	R (Max)	R_1 (Max)		
65000	89000	12	24	25	0.3	0.15	0.022	7000C
56500	75500	12	24	25	0.3	0.15	0.022	7000AC
58500	80000	14	26	27	0.3	0.15	0.024	7001C
51000	68000	14	26	27	0.3	0.15	0.026	7001AC
49500	68000	17	30	31	0.3	0.15	0.035	7002C
43000	58000	17	30	31	0.3	0.15	0.035	7002AC
45000	61500	19	33	34	0.3	0.15	0.045	7003C
39000	52500	19	33	34	0.3	0.15	0.045	7003AC
37500	51500	24	38	40	0.6	0.3	0.079	7004C
32500	44000	24	38	40	0.6	0.3	0.079	7004AC
32500	44500	29	43	45	0.6	0.3	0.091	7005C
28200	37500	29	43	45	0.6	0.3	0.091	7005AC
27400	37500	35	50	52	1	0.6	0.135	7006C
23900	32000	35	50	52	1	0.6	0.135	7006AC
24100	33000	40	57	59	1	0.6	0.170	7007C
21000	28000	40	57	59	1	0.6	0.170	7007AC
21600	29600	45	63	65	1	0.6	0.210	7008C
18800	25200	45	63	65	1	0.6	0.210	7008AC
19500	26700	50	70	72	1	0.6	0.265	7009C
16900	22700	50	70	72	1	0.6	0.265	7009AC
18000	24600	55	75	77	1	0.6	0.285	7010C
15600	20900	55	75	77	1	0.6	0.285	7010AC
16100	22100	61	84	86	1	0.6	0.420	7011C
14000	18800	61	84	86	1	0.6	0.420	7011AC
15000	20600	66	89	91	1	0.6	0.450	7012C
13100	17500	66	89	91	1	0.6	0.450	7012AC
14200	19400	71	94	96	1	0.6	0.470	7013C
12300	16500	71	94	96	1	0.6	0.470	7013AC
13000	17800	76	104	106	1	0.6	0.660	7014C
11300	15100	76	104	106	1	0.6	0.660	7014AC
12300	16800	81	109	111	1	0.6	0.695	7015C
10700	14300	81	109	111	1	0.6	0.695	7015AC
11400	15600	86	119	121	1	0.6	0.925	7016C
9900	13300	86	119	121	1	0.6	0.925	7016AC
10900	14900	91	124	126	1	0.6	0.960	7017C
9400	12700	91	124	126	1	0.6	0.960	7017AC
10100	13900	97	133	135.6	1.5	1	1.26	7018C
8800	11800	97	133	135.6	1.5	1	1.26	7018AC
9700	13300	102	138	140.6	1.5	1	1.36	7019C
8400	11300	102	138	140.6	1.5	1	1.36	7019AC
9300	12800	107	143	145.6	1.5	1	1.37	7020C
8100	10900	107	143	145.6	1.5	1	1.37	7020AC

Dimension Tables

Types and Designs

7900
7000
7200

BNH

TAH
TBH

NN3000
NNU4900

XRN
XRG

TAB
TAF

Angular Contact Ball Bearings

7200C Series Contact angle $\alpha = 15^\circ$

7200AC Series Contact angle $\alpha = 25^\circ$

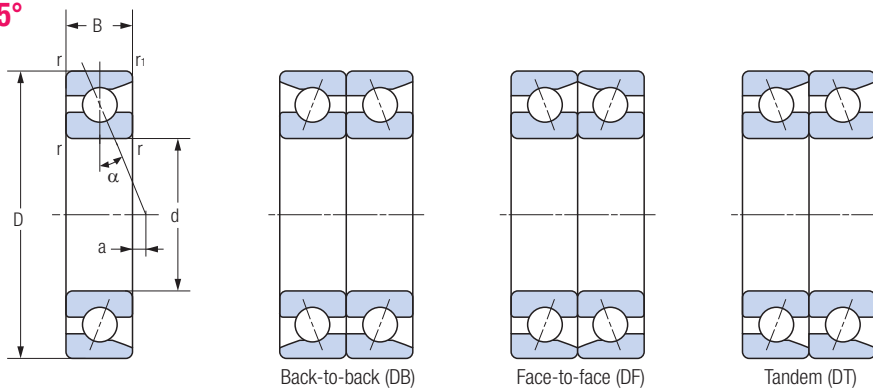

Bearing no.	Boundary dimensions (mm)					Load center a (mm)	Basic dynamic load rating Cr (kN)	Basic static load rating Cor (kN)
	d	D	B	r (Min)	r1 (Min)			
7200C	10	30	9	0.6	0.3	-2.2	6.95	3.30
7200AC	10	30	9	0.6	0.3	0.2	6.75	3.20
7201C	12	32	10	0.6	0.3	-2.5	7.95	3.90
7201AC	12	32	10	0.6	0.3	0.2	7.65	3.75
7202C	15	35	11	0.6	0.3	-2.6	8.70	4.55
7202AC	15	35	11	0.6	0.3	0.4	8.35	4.40
7203C	17	40	12	0.6	0.3	-2.7	10.9	5.90
7203AC	17	40	12	0.6	0.3	0.8	10.5	5.65
7204C	20	47	14	1	0.6	-3.1	14.7	8.15
7204AC	20	47	14	1	0.6	0.9	14.0	7.80
7205C	25	52	15	1	0.6	-3.1	16.7	10.3
7205AC	25	52	15	1	0.6	1.6	15.9	9.80
7206C	30	62	16	1	0.6	-2.7	23.2	14.9
7206AC	30	62	16	1	0.6	2.8	22.0	14.1
7207C	35	72	17	1.1	0.6	-2.3	30.5	20.1
7207AC	35	72	17	1.1	0.6	4	29.1	19.1
7208C	40	80	18	1.1	0.6	-2.1	36.5	25.4
7208AC	40	80	18	1.1	0.6	5	34.5	24.1
7209C	45	85	19	1.1	0.6	-2.0	41.0	29.0
7209AC	45	85	19	1.1	0.6	5.7	39.0	27.5
7210C	50	90	20	1.1	0.6	-1.9	43.0	32.0
7210AC	50	90	20	1.1	0.6	6.3	41.0	30.5
7211C	55	100	21	1.5	1	-1.6	53.0	40.0
7211AC	55	100	21	1.5	1	7.6	50.5	38.0
7212C	60	110	22	1.5	1	-1.2	64.5	49.5
7212AC	60	110	22	1.5	1	8.8	58.0	43.5
7213C	65	120	23	1.5	1	-0.8	73.5	59.0
7213AC	65	120	23	1.5	1	10.1	66.5	52.0
7214C	70	125	24	1.5	1	-0.7	80.0	65.0
7214AC	70	125	24	1.5	1	10.7	72.5	57.5
7215C	75	130	25	1.5	1	-0.7	83.5	70.0
7215AC	75	130	25	1.5	1	11.4	75.5	62.5
7216C	80	140	26	2	1	-0.3	93.5	78.0
7216AC	80	140	26	2	1	12.7	88.5	74.0
7217C	85	150	28	2	1	-0.4	100	85.0
7217AC	85	150	28	2	1	13.4	95.0	81.0
7218C	90	160	30	2	1	-0.6	124	105
7218AC	90	160	30	2	1	14.2	112	93.0
7219C	95	170	32	2.1	1.1	-0.7	133	115
7219AC	95	170	32	2.1	1.1	14.9	126	107
7220C	100	180	34	2.1	1.1	-0.8	150	128
7220AC	100	180	34	2.1	1.1	15.7	142	121

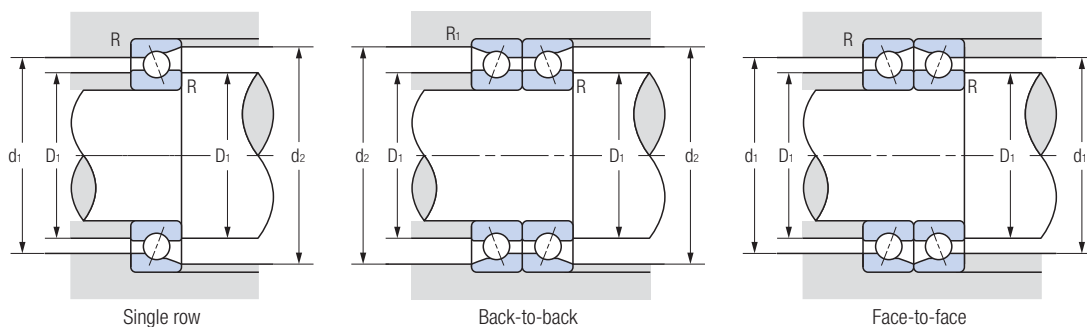

Dimension Tables

Rotation speed limit (rpm)		Corner radius (mm)					Mass (kg) (Reference)	Bearing no.
Grease lubrication	Oil lubrication	D ₁ (Min)	d ₁ (Max)	d ₂ (Max)	R (Max)	R ₁ (Max)		
58500	80000	15	25	27.4	0.6	0.3	0.034	7200C
51000	68000	15	25	27.4	0.6	0.3	0.034	7200AC
53000	72500	17	27	29.4	0.6	0.3	0.040	7201C
46000	62000	17	27	29.4	0.6	0.3	0.040	7201AC
46500	64000	20	30	32.4	0.6	0.3	0.048	7202C
40500	54500	20	30	32.4	0.6	0.3	0.048	7202AC
41000	56000	22	35	37.4	0.6	0.3	0.070	7203C
35500	47500	22	35	37.4	0.6	0.3	0.070	7203AC
34500	47500	26	41	43.4	1	0.6	0.110	7204C
30500	40500	26	41	43.4	1	0.6	0.110	7204AC
30000	41500	31	46	48.4	1	0.6	0.135	7205C
26400	35500	31	46	48.4	1	0.6	0.135	7205AC
25200	34500	36	56	58.4	1	0.6	0.210	7206C
22000	29600	36	56	58.4	1	0.6	0.210	7206AC
21800	29900	42	65	67	1	0.6	0.295	7207C
19000	25400	42	65	67	1	0.6	0.295	7207AC
19500	26700	47	73	75	1	0.6	0.380	7208C
16900	22700	47	73	75	1	0.6	0.380	7208AC
18000	24600	52	78	80	1	0.6	0.430	7209C
15600	20900	52	78	80	1	0.6	0.430	7209AC
16700	22900	57	83	85	1	0.6	0.485	7210C
14500	19400	57	83	85	1	0.6	0.485	7210AC
15000	20600	64	91	94.6	1.5	1	0.635	7211C
13100	17500	64	91	94.6	1.5	1	0.635	7211AC
13700	18800	69	101	104.6	1.5	1	0.820	7212C
12000	16000	69	101	104.6	1.5	1	0.820	7212AC
12600	17300	74	111	114.6	1.5	1	1.02	7213C
11000	14700	74	111	114.6	1.5	1	1.02	7213AC
12000	16400	79	116	119.6	1.5	0.8	1.12	7214C
10400	13900	79	116	119.6	1.5	0.8	1.12	7214AC
11400	15600	84	121	124.6	1.5	1	1.23	7215C
9900	13300	84	121	124.6	1.5	1	1.23	7215AC
10600	14500	90	130	134	2	1	1.50	7216C
9200	12400	90	130	134	2	1	1.50	7216AC
9900	13600	95	140	144	2	1	1.87	7217C
8600	11600	95	140	144	2	1	1.87	7217AC
9300	12800	100	150	154	2	1	2.30	7218C
8100	10900	100	150	154	2	1	2.30	7218AC
8800	12100	107	158	163	2	1	2.78	7219C
7700	10300	107	158	163	2	1	2.78	7219AC
8300	11400	112	168	173	2	1	3.32	7220C
7200	9700	112	168	173	2	1	3.32	7220AC

Types and Designs

7900
7000
7200

BNH

TAH
TBH

NN3000
NNU4900

XRN
XRG

TAB
TAF

High-speed Angular Contact Ball Bearings

BNH Series



Nomenclature of Bearing Numbers

SH6- BNH 0 10 T DB /GL P4

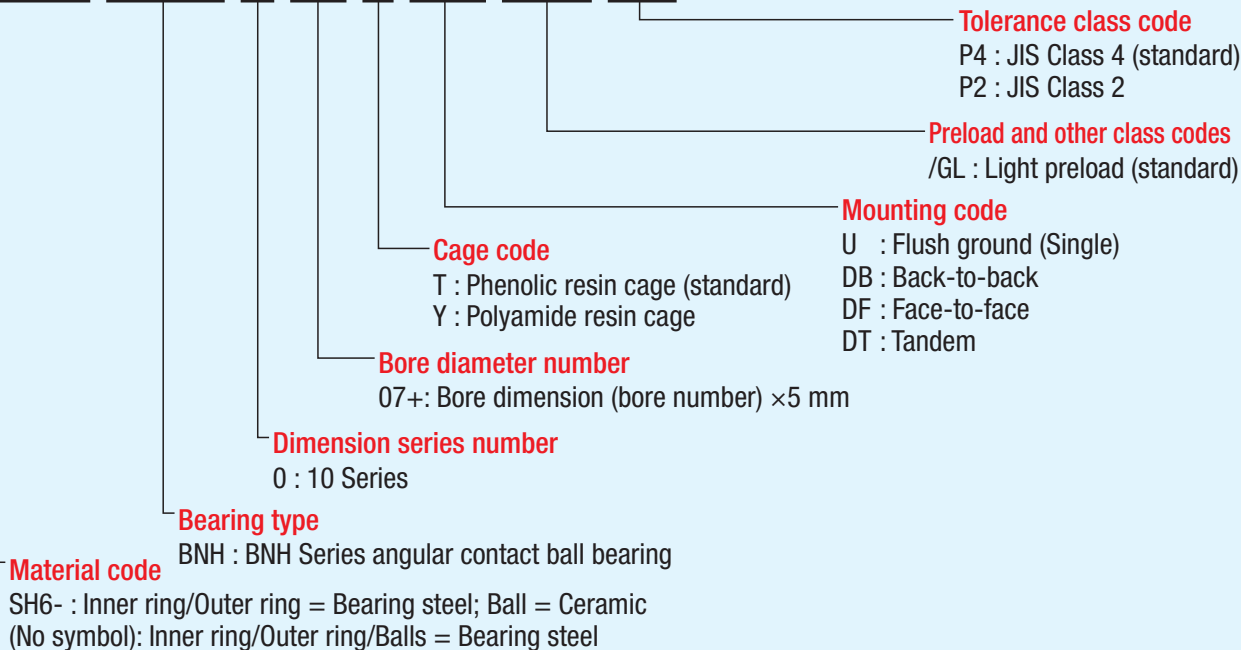

Features

- Smaller machine steel balls, higher speeds, and lower temperatures than previous angular contact ball bearings. Mainly used for the main spindle of high-speed machining centers.
- Ceramic ball type also available.

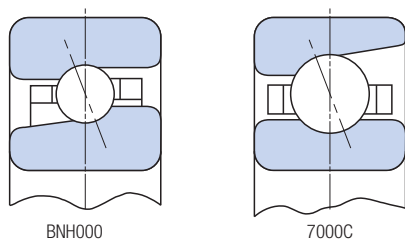

Preload

Light preload as standard. See page 19 for information about preloads.

Ceramic Ball Types

- Bearings with ceramic balls that are less dense than bearing steel balls also are available for lower centrifugal force when balls rotate at high speeds.
- The characteristics of ceramic and bearing steel are shown in the table below.
- The bearing numbers of bearings that use ceramic balls start with "SH6-".
- Preload and axial rigidity is approximately 1.2 times that of bearing steel type bearings.

Contact Angle

15° contact angle provided as standard.

Cage

Outer ring guided phenolic resin cage provided as standard. Ball guide polyamide resin cage also available.

Dimensional Accuracy, Rotational Accuracy

JIS Class 4 compliance as standard. See page 7 for details.

Comparison of Ceramic and Bearing Steel Characteristics

Features	Unit	Ceramic (Si ₃ N ₄)	Bearing steels (SUJ2)
Heat resistance	°C	800	180
Density	g/cc	3.2	7.8
Linear expansion coefficient	1/°C	3.2×10 ⁻⁶	12.5×10 ⁻⁶
Hardness	Hv	1400~1700	700~800
Longitudinal elastic coefficient	GPa	314	206
Poisson's ratio	—	0.26	0.30
Corrosion resistance	—	Good	No good
Magnetism	—	Non-magnetic substance	Strongly magnetic substance
Conductivity	—	Insulator	Conductor
Crystal chemical bonding	—	Covalent	Metallic

High-speed Angular Contact Ball Bearings BNH Series

Contact angle 15°

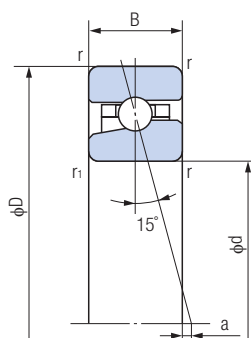

Bearing no.	Boundary dimensions (mm)					Load center a (mm)	Basic dynamic load rating Cr (kN)	Basic static load rating Cor (kN)
	d	D	B	r (Min)	r1 (Min)			
BNH007	35	62	14	1	0.6	-0.5	11.6	9.95
BNH008	40	68	15	1	0.6	-0.3	14.8	12.9
BNH009	45	75	16	1	0.6	0	15.5	14.5
BNH010	50	80	16	1	0.6	0.7	16.1	15.9
BNH011	55	90	18	1.1	0.6	0.7	20.0	20.1
BNH012	60	95	18	1.1	0.6	1.4	20.8	21.9
BNH013	65	100	18	1.1	0.6	2.1	21.5	23.4
BNH014	70	110	20	1.1	0.6	2.1	29.4	31.5
BNH015	75	115	20	1.1	0.6	2.7	29.8	32.5
BNH016	80	125	22	1.1	0.6	2.7	35.0	39.0
BNH017	85	130	22	1.1	0.6	3.4	35.5	40.0
BNH018	90	140	24	1.5	1	3.4	46.5	53.0
BNH019	95	145	24	1.5	1	4.1	47.0	55.0
BNH020	100	150	24	1.5	1	4.7	48.0	56.5
BNH021	105	160	26	2	1	4.8	54.5	65.0
BNH022	110	170	28	2	1	4.8	61.0	74.0
BNH024	120	180	28	2	1	6.1	63.0	79.0
BNH026	130	200	33	2	1	5.6	83.5	105
BNH028	140	210	33	2	1	6.9	86.0	112
BNH030	150	225	35	2.1	1.1	7.6	102	132
BNH032	160	240	38	2.1	1.1	7.8	110	145
BNH034	170	260	42	2.1	1.1	7.8	129	173

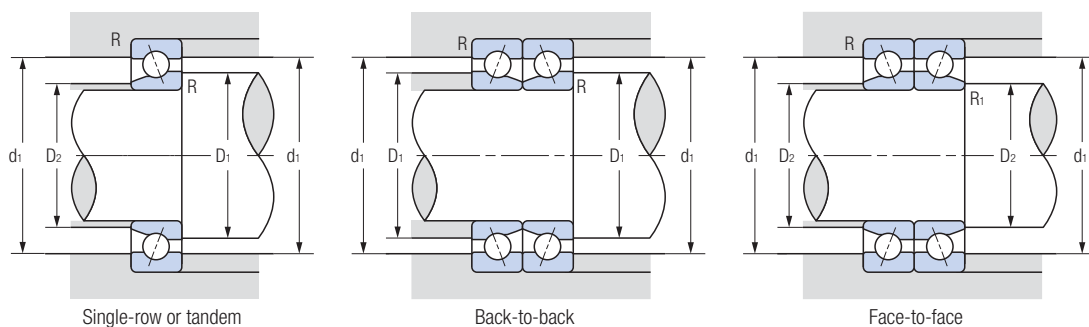

Single-row or tandem

Back-to-back

Face-to-face

Rotation speed limit (rpm)		Corner radius (mm)					Mass (kg) (Reference)	Bearing no.
Grease lubrication	Oil lubrication	D ₁ (Min)	D ₂ (Min)	d ₁ (Max)	R (Max)	R ₁ (Max)		
28900	39000	40	39	57	1	0.6	0.167	BNH007
26000	35000	45	44	63	1	0.6	0.200	BNH008
23400	31500	50	49.5	70	1	0.6	0.260	BNH009
21600	29200	55	54.5	75	1	0.6	0.280	BNH010
19400	26200	61	59.5	84	1	0.6	0.400	BNH011
18100	24500	66	64.5	89	1	0.6	0.433	BNH012
17000	23000	71	69.5	94	1	0.6	0.460	BNH013
15600	21100	76	74.5	104	1	0.6	0.650	BNH014
14800	20000	81	79.5	109	1	0.6	0.690	BNH015
13700	18500	86	84.5	119	1	0.6	0.930	BNH016
13100	17700	91	89.5	124	1	0.6	0.973	BNH017
12200	16500	97	95.5	133	1.5	1	1.27	BNH018
11700	15800	102	100.5	138	1.5	1	1.33	BNH019
11200	15200	107	105.5	143	1.5	1	1.39	BNH020
10600	14300	115	110.5	150	2	1	1.77	BNH021
10000	13600	120	115.5	160	2	1	2.18	BNH022
9400	12700	130	125.5	170	2	1	2.32	BNH024
8500	11500	140	135.5	190	2	1	3.46	BNH026
8000	10900	150	145.5	200	2	1	3.68	BNH028
7500	10100	161	156	213	2	1	4.55	BNH030
7000	9500	172	166	228	2	1	5.57	BNH032
6500	8800	182	176	248	2	1	7.50	BNH034

Dimension Tables

Types and Designs

7900
7000
7200

BNH

TAH
TBH

NN3000
NNU4900

XRN
XRG

TAB
TAF

Thrust Load Angular Contact Ball Bearings

TAH/TBH Series



Nomenclature of Bearing Numbers

90 TBH 10 T DB /GM P4

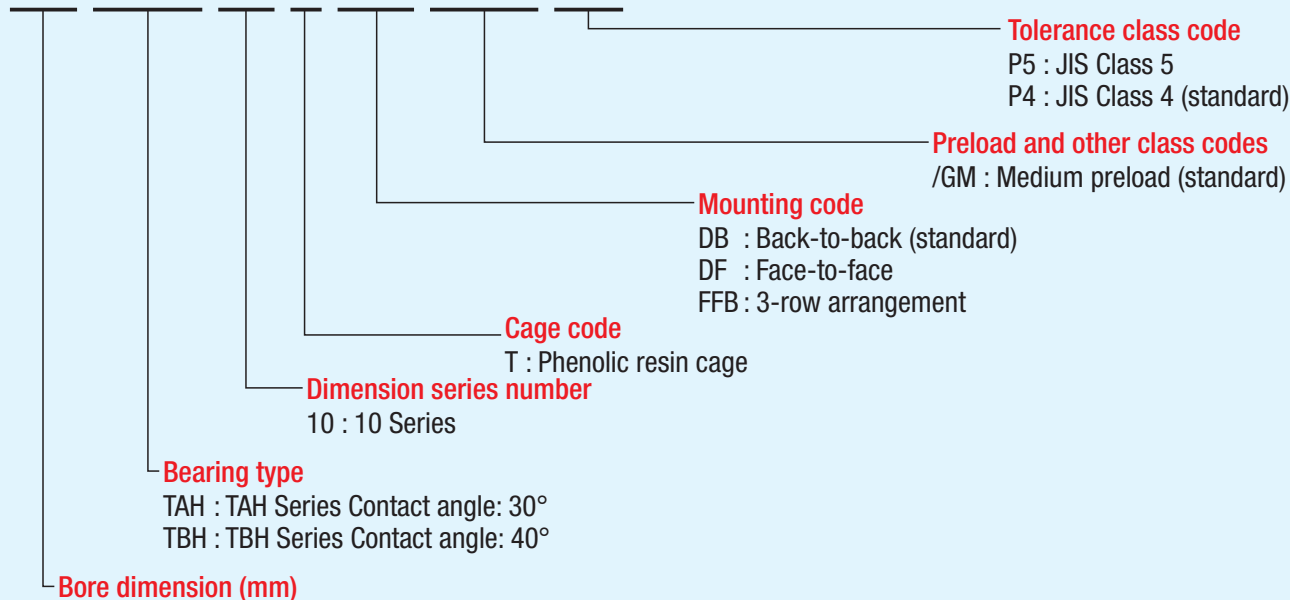

Features

- Same number and diameter of balls as the TAD20 type double-direction thrust angular contact ball bearings, and with smaller contact angles, 30° (TAH Series) or 40° (TBH Series), providing better high-speed performance with no separable ring.
- 2B width dimension of a duplex mounting (DB or DF) that is equivalent to the B1 dimension of the TAD20 Type. TAH/TBH Series are interchangeable by changing the method used to secure them to the shaft.

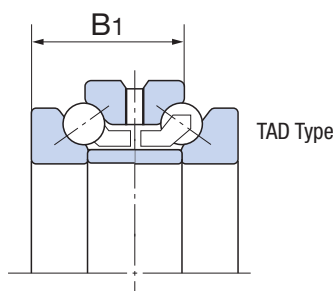
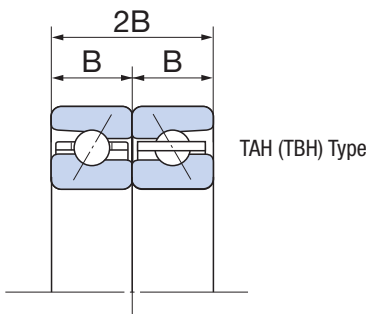

Contact Angle

30° contact angle for the TAH Series, 40° contact angle for the TBH Series.

Cage

Outer ring guided phenolic resin cage provided as standard.

Dimensional Accuracy, Rotational Accuracy

JIS Class 4 compliance as standard, but the external ring outside diameter has smaller tolerances compared to the jointly used radial bearing. See page 9 for details.

Preload

Medium preload as standard. See page 19 for information about preloads.

Thrust Load Angular Contact Ball Bearings TAH Series

Contact angle 30°

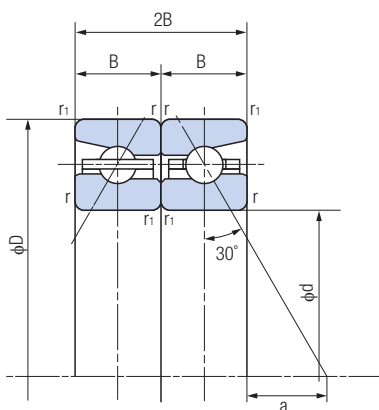

1N=0.102kgf

Bearing no.	Boundary dimensions (mm)					Load center a (mm)	Basic dynamic load rating Ca (kN)	Basic static load rating Coa (kN)
	d	D	2B	r (Min)	r1 (Min)			
50TAH10DB	50	80	28.5	1	0.6	11.6	19.2	40.5
55TAH10DB	55	90	33	1.1	0.6	12.7	23.8	51.0
60TAH10DB	60	95	33	1.1	0.6	14.1	24.7	56.0
65TAH10DB	65	100	33	1.1	0.6	15.6	25.6	61.0
70TAH10DB	70	110	36	1.1	0.6	17.0	35.0	80.0
75TAH10DB	75	115	36	1.1	0.6	18.4	35.5	83.5
80TAH10DB	80	125	40.5	1.1	0.6	19.5	41.5	99.5
85TAH10DB	85	130	40.5	1.1	0.6	20.9	42.0	104
90TAH10DB	90	140	45	1.5	1	21.9	55.5	135
95TAH10DB	95	145	45	1.5	1	23.4	56.0	141
100TAH10DB	100	150	45	1.5	1	24.8	57.0	147
105TAH10DB	105	160	49.5	2	1	25.9	64.5	168
110TAH10DB	110	170	54	2	1	26.9	73.0	191
120TAH10DB	120	180	54	2	1	29.8	75.0	207
130TAH10DB	130	200	63	2	1	31.9	99.5	269
140TAH10DB	140	210	63	2	1	34.8	103	291
150TAH10DB	150	225	67.5	2.1	1.1	37.3	121	340
160TAH10DB	160	240	72	2.1	1.1	39.7	131	375
170TAH10DB	170	260	81	2.1	1.1	41.8	154	445

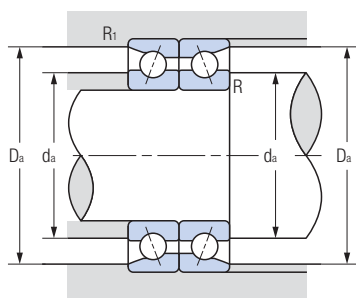

Dimension Tables

Rotation speed limit (rpm)		Corner radius (mm)				Mass (kg) (Reference)	Bearing no.
Grease lubrication	Oil lubrication	da (Min)	Da (Max)	R (Min)	R ₁ (Min)		
11500	14600	61	75	1	0.6	0.266	50TAH10DB
10300	13100	68	84	1	0.6	0.405	55TAH10DB
9700	12300	73	89	1	0.6	0.432	60TAH10DB
9100	11500	78	94	1	0.6	0.460	65TAH10DB
8300	10600	85	104	1	0.6	0.622	70TAH10DB
7900	10000	90	109	1	0.6	0.655	75TAH10DB
7300	9200	97	118	1	0.6	0.900	80TAH10DB
7000	8800	102	123	1	0.6	0.944	85TAH10DB
6500	8200	107.5	132	1.5	1	1.24	90TAH10DB
6200	7900	112.5	137	1.5	1	1.30	95TAH10DB
6000	7600	117.5	142	1.5	1	1.35	100TAH10DB
5600	7100	125	151	2	1	1.75	105TAH10DB
5300	6800	132	160	2	1	2.20	110TAH10DB
5000	6300	142	170	2	1	2.36	120TAH10DB
4500	5700	156	188	2	1	3.52	130TAH10DB
4200	5400	166	198	2	1	3.75	140TAH10DB
4000	5000	178	212	2	1	4.59	150TAH10DB
3700	4700	190	227	2	1	5.62	160TAH10DB
3400	4400	204	245	2	1	7.63	170TAH10DB

Types and Designs

7900
7000
7200

BNH

TAH
TBH

NN3000
NNU4900

XRN
XRG

TAB
TAF

Thrust Load Angular Contact Ball Bearings TBH Series

Contact angle 40°

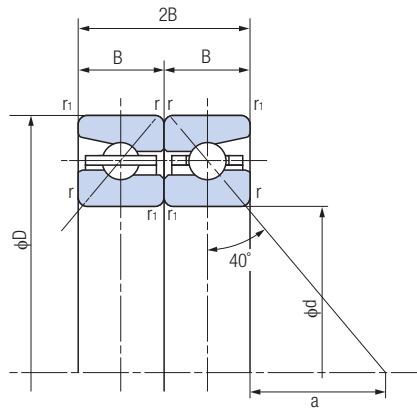

1N=0.102kgf

Bearing no.	Boundary dimensions (mm)					Load center a (mm)	Basic dynamic load rating Ca (kN)	Basic static load rating Coa (kN)
	d	D	2B	r (Min)	r1 (Min)			
50TBH10DB	50	80	28.5	1	0.6	20.2	22.8	53.0
55TBH10DB	55	90	33	1.1	0.6	22.2	28.2	67.0
60TBH10DB	60	95	33	1.1	0.6	24.3	29.3	73.0
65TBH10DB	65	100	33	1.1	0.6	26.4	30.0	79.5
70TBH10DB	70	110	36	1.1	0.6	28.8	41.5	104
75TBH10DB	75	115	36	1.1	0.6	30.9	42.0	109
80TBH10DB	80	125	40.5	1.1	0.6	32.9	49.0	130
85TBH10DB	85	130	40.5	1.1	0.6	35.0	50.0	136
90TBH10DB	90	140	45	1.5	1	37.0	65.5	176
95TBH10DB	95	145	45	1.5	1	39.1	66.5	184
100TBH10DB	100	150	45	1.5	1	41.2	67.5	191
105TBH10DB	105	160	49.5	2	1	43.2	76.5	219
110TBH10DB	110	170	54	2	1	45.3	86.0	249
120TBH10DB	120	180	54	2	1	49.5	88.5	269
130TBH10DB	130	200	63	2	1	53.5	118	350
140TBH10DB	140	210	63	2	1	57.7	121	380
150TBH10DB	150	225	67.5	2.1	1.1	61.8	143	445
160TBH10DB	160	240	72	2.1	1.1	65.9	155	490
170TBH10DB	170	260	81	2.1	1.1	70.0	182	580

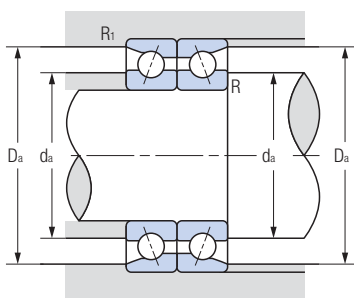

Rotation speed limit (rpm)		Corner radius (mm)				Mass (kg) (Reference)	Bearing no.
Grease lubrication	Oil lubrication	da (Min)	Da (Max)	R (Min)	R ₁ (Min)		
10000	13200	61	75	1	0.6	0.266	50TBH10DB
8900	11800	68	84	1	0.6	0.405	55TBH10DB
8300	11000	73	89	1	0.6	0.432	60TBH10DB
7900	10400	78	94	1	0.6	0.460	65TBH10DB
7200	9500	85	104	1	0.6	0.622	70TBH10DB
6800	9000	90	109	1	0.6	0.655	75TBH10DB
6300	8300	97	118	1	0.6	0.900	80TBH10DB
6000	7900	102	123	1	0.6	0.944	85TBH10DB
5600	7400	107.5	132	1.5	1	1.24	90TBH10DB
5400	7100	112.5	137	1.5	1	1.30	95TBH10DB
5200	6800	117.5	142	1.5	1	1.35	100TBH10DB
4900	6400	125	151	2	1	1.75	105TBH10DB
4600	6100	132	160	2	1	2.20	110TBH10DB
4300	5700	142	170	2	1	2.36	120TBH10DB
3900	5200	156	188	2	1	3.52	130TBH10DB
3700	4900	166	198	2	1	3.75	140TBH10DB
3400	4500	178	212	2	1	4.59	150TBH10DB
3200	4200	190	227	2	1	5.62	160TBH10DB
3000	3900	204	245	2	1	7.63	170TBH10DB

Types and Designs

7900
7000
7200

BNH

TAH
TBH

NN3000
NNU4900

XRN
XRG

TAB
TAF

Multiple-row Cylindrical Roller Bearings

NN3000 Series/ NNU4900 Series



Nomenclature of Bearing Number

NN 30 06 W33 M2 K C1NA P4

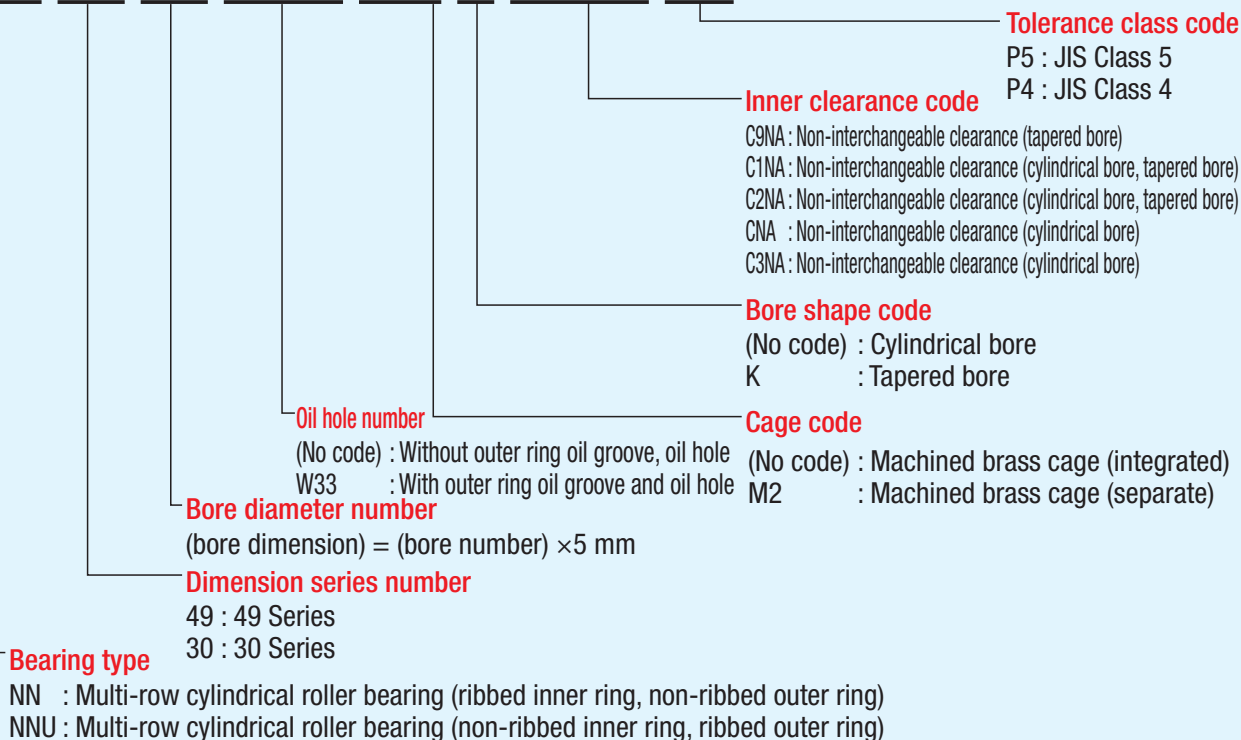

Features

- Comparatively simple construction provides high accuracy. A large number of rollers for high rigidity.
- Fewer sliding sections than a tapered roller bearing so less heat is generated.
- Tapered bore bearing allows adjusting of radial internal clearance during assembly.
- This bearing cannot bear axial load, so normally it is used in combination with a thrust bearing.

Cage

Both the NN3000 Series and NNU4900 Series are provided with brass alloy roller guide cage as standard.

Dimensional Accuracy, Rotational Accuracy

- Conforms to JIS Class 5 or Class 4. See page 7 for details.
- Nachi defines its own tolerance values for accuracy of dimensions. See page 11 for details.

Radial Internal Clearance

Nachi defines its own non-interchangeable clearances for cylindrical bores and tapered bores in order to minimize axial run-out inconsistency. See page 21 for details.

Outer Ring Oil Hole Dimensions

The table below shows the dimensions of the outer ring oil hole and oil groove (W33 Specification).

Outer ring width dimension B (mm)		Oil hole diameter dH (mm)	Oil groove width A (mm)
Over	Incl.		
—	19	2	3.5
19	25	2	4
25	35	3	6
35	50	4	8
50	80	6	10
80	—	8	12

Nominal outside diameter dimensions D (mm)		Number of oil holes N
Over	Incl.	
—	250	4
250	—	6

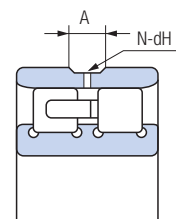

Multiple-row Cylindrical Roller Bearing NN3000 Series

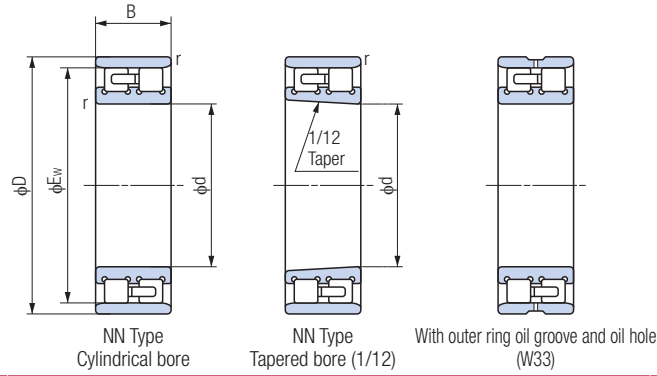

Bearing no.		Boundary dimensions (mm)					Basic dynamic load rating Cr (kN)	Basic static load rating Cor (kN)
Cylindrical bore	Tapered bore	d	D	B	Ew	r (Min)		
NN3005	NN3005K	25	47	16	41.3	0.6	25.8	30.0
NN3006	NN3006K	30	55	19	48.5	1	31.0	37.0
NN3007	NN3007K	35	62	20	55	1	39.5	50.0
NN3008	NN3008K	40	68	21	61	1	43.5	55.5
NN3009	NN3009K	45	75	23	67.5	1	52.0	65.5
NN3010	NN3010K	50	80	23	72.5	1	53.0	72.5
NN3011	NN3011K	55	90	26	81	1.1	69.5	96.5
NN3012	NN3012K	60	95	26	86.1	1.1	73.5	106
NN3013	NN3013K	65	100	26	91	1.1	77.0	116
NN3014	NN3014K	70	110	30	100	1.1	97.5	148
NN3015	NN3015K	75	115	30	105	1.1	96.5	149
NN3016	NN3016K	80	125	34	113	1.1	119	186
NN3017	NN3017K	85	130	34	118	1.1	125	201
NN3018	NN3018K	90	140	37	127	1.5	143	228
NN3019	NN3019K	95	145	37	132	1.5	150	246
NN3020	NN3020K	100	150	37	137	1.5	157	265
NN3021	NN3021K	105	160	41	146	2	198	320
NN3022	NN3022K	110	170	45	155	2	229	375
NN3024	NN3024K	120	180	46	165	2	239	405
NN3026	NN3026K	130	200	52	182	2	284	475
NN3028	NN3028K	140	210	53	192	2	298	515
NN3030	NN3030K	150	225	56	206	2.1	335	585
NN3032	NN3032K	160	240	60	219	2.1	375	660
NN3034	NN3034K	170	260	67	236	2.1	450	805
NN3036	NN3036K	180	280	74	255	2.1	565	995
NN3038	NN3038K	190	290	75	265	2.1	595	1080
NN3040	NN3040K	200	310	82	282	2.1	655	1170
NN3044	NN3044K	220	340	90	310	3	815	1480
NN3048	NN3048K	240	360	92	330	3	855	1600
NN3052	NN3052K	260	400	104	364	4	1080	2070
NN3056	NN3056K	280	420	106	384	4	1080	2080
NN3060	NN3060K	300	460	118	418	4	1430	2740
NN3064	NN3064K	320	480	121	438	4	1430	2750

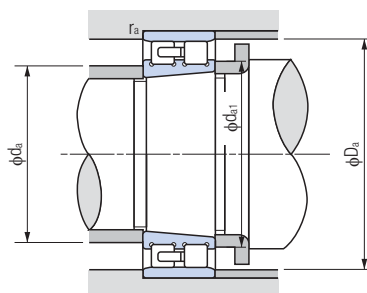

Dimension Tables

Rotation speed limit (rpm)		Corner radius (mm)				Mass (kg) (Reference) (Tapered bore)	Bearing no. (Tapered bore)
Grease lubrication	Oil lubrication	da (Min)	da1 (Min)	Da			
				(Max)	(Min)		
21300	25000	30	30	42	41.8	0.6	NN3005K
18000	21200	36	37	49	49	1	NN3006K
15800	18600	41	42	56	56	1	NN3007K
14200	16700	46	48	62	62	1	NN3008K
12800	15000	51	52	69	69	1	NN3009K
11700	13800	56	58	74	74	1	NN3010K
10500	12400	62	64	83	82	1	NN3011K
9800	11600	67	68	88	87	1	NN3012K
9200	10900	72	74	93	92	1	NN3013K
8500	10000	77	78	103	101	1	NN3014K
8000	9400	82	84	108	106	1	NN3015K
7500	8800	87	90	118	114	1	NN3016K
7100	8300	92	96	123	119	1	NN3017K
6600	7800	98.5	100	131.5	129	1.5	NN3018K
6300	7500	103.5	106	136.5	134	1.5	NN3019K
6100	7200	108.5	112	141.5	139	1.5	NN3020K
5800	6800	115	116	150	148	2	NN3021K
5400	6400	120	122	160	157	2	NN3022K
5100	6000	130	132	170	167	2	NN3024K
4600	5400	140	144	190	183	2	NN3026K
4300	5100	150	154	200	194	2	NN3028K
4100	4800	162	164	213	208	2	NN3030K
3800	4500	172	174	228	221	2	NN3032K
3500	4200	182	184	248	238	2	NN3034K
3300	3900	192	196	268	257	2	NN3036K
3200	3700	202	206	278	267	2	NN3038K
2900	3500	212	216	298	285	2	NN3040K
2700	3200	234	238	326	313	2.5	NN3044K
2500	3000	254	256	346	333	2.5	NN3048K
2300	2700	278	280	382	367	3	NN3052K
2100	2500	298	300	402	387	3	NN3056K
2000	2300	318	325	442	421	3	NN3060K
1900	2200	338	345	462	442	3	NN3064K

Types and Designs

7900
7000
7200

BNH

TAH
TBH

NN3000
NNU4900

XRN
XRG

TAB
TAF

Multiple-row Cylindrical Roller Bearing NNU4900 Series

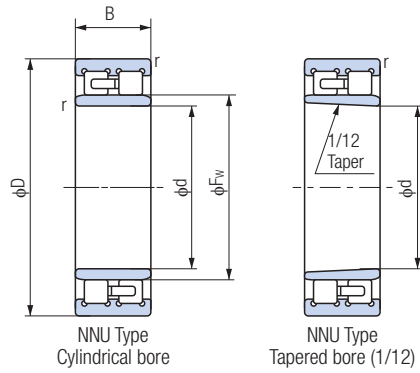

Bearing no.		Boundary dimensions (mm)					Basic dynamic load rating Cr (kN)	Basic static load rating Cor (kN)
Cylindrical bore	Tapered bore	d	D	B	Ew	r (Min)		
NNU4920	NNU4920K	100	140	40	113	1.1	155	305
NNU4921	NNU4921K	105	145	40	118	1.1	161	325
NNU4922	NNU4922K	110	150	40	123	1.1	167	335
NNU4924	NNU4924K	120	165	45	134.5	1.1	183	360
NNU4926	NNU4926K	130	180	50	146	1.5	275	565
NNU4928	NNU4928K	140	190	50	156	1.5	283	585
NNU4930	NNU4930K	150	210	60	168.5	2	350	715
NNU4932	NNU4932K	160	220	60	178.5	2	365	760
NNU4934	NNU4934K	170	230	60	188.5	2	375	805
NNU4936	NNU4936K	180	250	69	202	2	480	1020
NNU4938	NNU4938K	190	260	69	212	2	485	1060
NNU4940	NNU4940K	200	280	80	225	2.1	570	1220
NNU4944	NNU4944K	220	300	80	245	2.1	600	1330
NNU4948	NNU4948K	240	320	80	265	2.1	625	1450
NNU4952	NNU4952K	260	360	100	292	2.1	935	2100
NNU4956	NNU4956K	280	380	100	312	2.1	960	2230
NNU4960	NNU4960K	300	420	118	339	3	1230	2880
NNU4964	NNU4964K	320	440	118	359	3	1270	3050

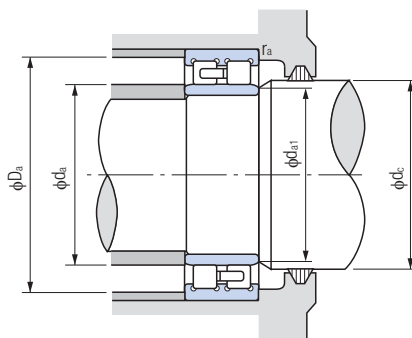

Rotation speed limit (rpm)		Corner radius (mm)						Mass (kg) (Reference) (Tapered bore)	Bearing no. (Tapered bore)
Grease lubrication	Oil lubrication	da		da1 (Min)	dc (Min)	Da (Max)	ra (Max)		
		(Min)	(Max)						
6300	7500	106.5	111	110	115	133.5	1	1.77	NNU4920K
6100	7200	111.5	116	115	120	138.5	1	1.85	NNU4921K
5800	6900	116.5	121	120	125	143.5	1	1.93	NNU4922K
5300	6300	126.5	133	130	137	158.5	1	2.65	NNU4924K
4900	5800	138	144	142	148	172	1.5	3.55	NNU4926K
4600	5400	148	154	151	158	182	1.5	3.80	NNU4928K
4200	5000	159	166	162	171	201	2	5.95	NNU4930K
4000	4700	169	176	172	182	211	2	6.25	NNU4932K
3800	4500	179	186	182	192	221	2	6.60	NNU4934K
3500	4200	189	199	194	205	241	2	9.50	NNU4936K
3400	4000	199	209	204	215	251	2	10.0	NNU4938K
3200	3700	211	222	214	228	269	2	10.1	NNU4940K
2900	3400	231	242	234	248	289	2	15.5	NNU4944K
2700	3200	251	262	254	269	309	2	17.0	NNU4948K
2400	2900	271	288	276	296	349	2	28.3	NNU4952K
2300	2700	291	308	296	316	369	2	30.3	NNU4956K
2100	2500	313	335	320	343	407	2.5	46.7	NNU4960K
2000	2300	333	335	340	363	427	2.5	49.6	NNU4964K

Types and Designs

7900
7000
7200

BNH

TAH
TBH

NN3000
NNU4900

XRN
XRG

TAB
TAF



Cross Tapered Roller Bearings
XRN Series/XRG Series

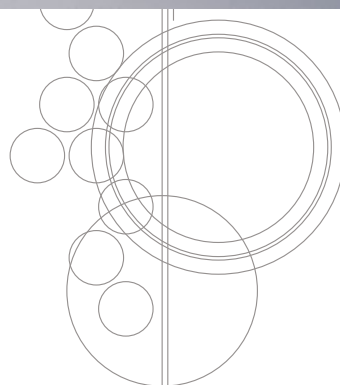

A bearing that provides functions equivalent to a duplex tapered roller bearing, but in the size of a single bearing. The rolling elements are arranged in alternating orientation between the separable ring and the primary ring.

Features

- A bearing that can stand up to radial loads, axial loads, and moment loads.
- Bearing applications can be simplified, fewer components reduce weight and size, reduced assembly time.
- Shaft thermal expansion has minimal affect on bearing preload promoting machine accuracy.
- Tapered rollers are used and the center of rotation is maintained for smooth rotation, even under preload.
- Polyamide resin spacers are inserted between rollers to minimize roller-to-roller friction (except XRGV Type).
- Angle of contact is approximately 45°.

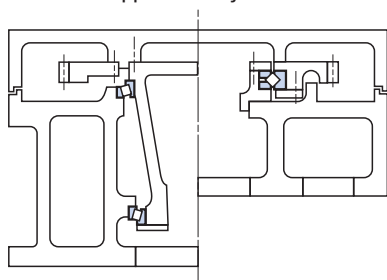

Duplex Tapered Roller Bearings Cross Tapered Roller Bearings

Installation Example of Tapered Roller Bearing and Cross Tapered Roller Bearing

Accuracy

Nachi defines its own accuracy standards. See page 9 for details.

Mechanism

The XRN Series is a separable inner ring, primary outer ring type bearing, intended mainly for applications where the focus is on outer ring accuracy under outer ring rotation. The XRG Series, on the other hand mainly is used where the focus is on inner ring rotation accuracy during inner ring rotation.

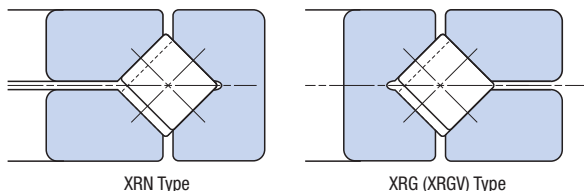

XRN Type

XRG (XRGV) Type

Main Applications

- Work table of a machining center, grinding machine, etc.
- Work spindle of a lathe, grinding machine, etc.
- Large-scale milling machine, drilling machine, or other indexing machine.
- Pivot of parabolic antenna, etc.

Nomenclature of Bearing Number

300 XRN 40

- 300** : Bore dimension (mm)
- XRN** : Bearing type
XRN : XRN Series Inner ring separable type
XRG : XRG Series Outer ring separable type
XRGV : XRG Series Outer ring separable type, no spacer
- 40** : Outside diameter value
Outside diameter divided by 10

Axial Load and Axial Displacement

XRN Series

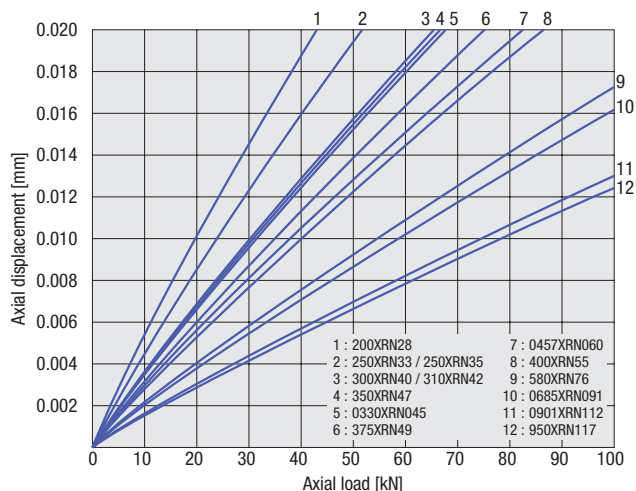

XRG Series

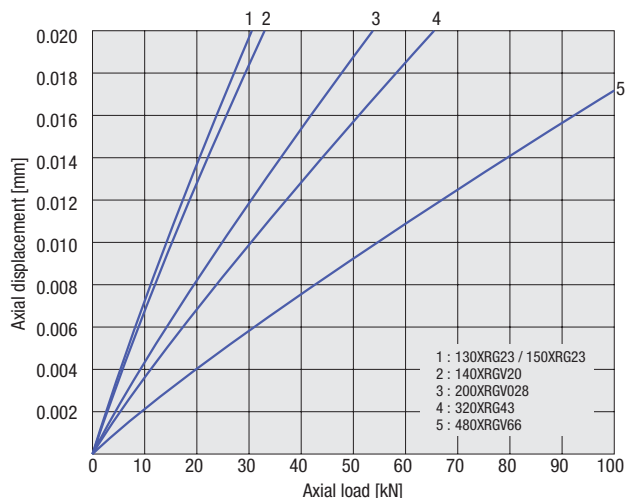

Cross Tapered Roller Bearings XRN Series

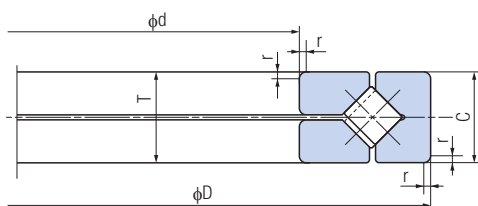

Bearing no.	Boundary dimensions (mm)					Basic dynamic load rating C_a (kN)	Basic static load rating C_{0a} (kN)
	d	D	T	C	r		
150XRN23	150	230	30	30	1.5	105	335
200XRN28	200	280	30	30	1.5	144	520
250XRN33	250	330	30	30	1	164	650
250XRN35	250	350	40	40	3	170	680
300XRN40	300	400	38	38	3	268	985
310XRN42	310	420	40	40	2.5	260	1070
0330XRN045	330.2	457.2	63.5	63.5	3.3	400	1540
350XRN47	350	470	50	50	3	284	1230
375XRN49	375	490	45	45	2.5	290	1280
400XRN55	400	550	60	60	3.5	365	1900
0457XRN060	457.2	609.6	63.5	63.5	3.3	370	1670
580XRN76	580	760	80	80	6.4	830	3800
0685XRN091	685.8	914.4	79.375	79.375	3.3	1090	5000
950XRN117	950	1170	85	85	3	1440	7400

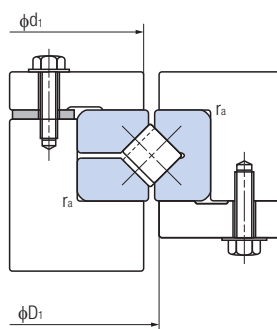

Rotation speed limit (rpm)		Corner radius (mm)			Mass (kg) (Reference)	Bearing no.
Grease lubrication	Oil lubrication	d_1 (Min)	D_1 (Max)	r_a (Max)		
600	1200	182	197	1	5.11	150XRN23
480	950	235	249	1	6.43	200XRN28
400	800	285	298	1	7.77	250XRN33
400	800	302	312	1.5	13.6	250XRN35
330	650	345	369	2.5	14.8	300XRN40
320	630	358	380	2	18.1	310XRN42
290	580	380	409	2	35.4	0330XRN045
280	560	410	424	1.5	27.7	350XRN47
260	530	430	445	1.5	25.5	375XRN49
250	500	475	492	1.5	48.8	400XRN55
220	440	535	554	2	57.1	0457XRN060
170	340	667	691	4	108	580XRN76
140	280	807	834	2	161	0685XRN091
100	200	1050	1084	2.5	218	950XRN117

Dimension Tables

Types and Designs

7900
7000
7200

BNH

TAH
TBH

NN3000
NNU4900

XRN
XRG

TAB
TAF

Cross Tapered Roller Bearings XRG Series

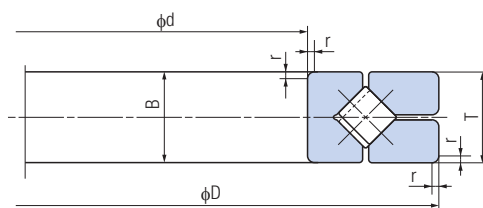

Bearing no.	Boundary dimensions (mm)					Basic dynamic load rating C_a (kN)	Basic static load rating C_{0a} (kN)
	d	D	T	B	r		
130XRG23	130	230	30	30	1.5	105	335
140XRGV20	140	200	25	25	1.5	89	299
150XRG23	150	230	30	30	1.5	105	335
200XRGV028	200	285	30	30	1	170	655
320XRG43	320	430	40	40	2.5	260	1070
480XRGV66	480	660	50	49.5	4	405	2110

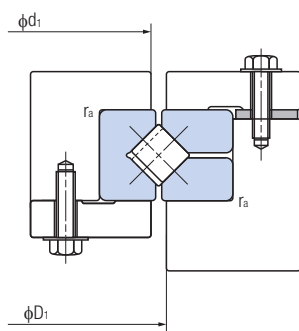

Rotation speed limit (rpm)		Corner radius (mm)			Mass (kg) (Reference)	Bearing no.
Grease lubrication	Oil lubrication	d_1 (Min)	D_1 (Max)	r_a (Max)		
650	1250	182	197	1	5.97	130XRG23
680	1350	162	176	1	2.86	140XRGV20
600	1200	182	197	1	5.11	150XRG23
480	950	235	249	1	7.13	200XRGV028
300	600	358	382	2	18.9	320XRG43
200	400	550	572	3	61.0	480XRGV66

Dimension Tables

Types and Designs

7900
7000
7200

BNH

TAH
TBH

NN3000
NNU4900

XRN
XRG

TAB
TAF

Ball Screw Support Bearings

TAB/TAF Series

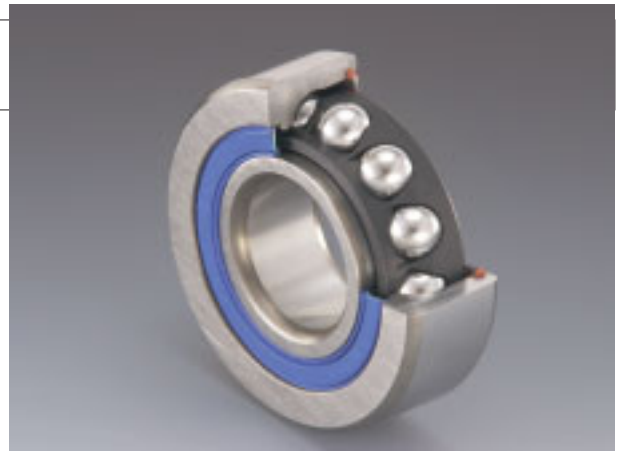

TAB Series

Ball screw support bearings are used in high accuracy and high-speed precision machine tools, precision measuring machines, robots, and other machines that have built in precision feed actuators.

Nomenclature of Bearing Numbers

30 TAB 06 DB -2LR /GM P4

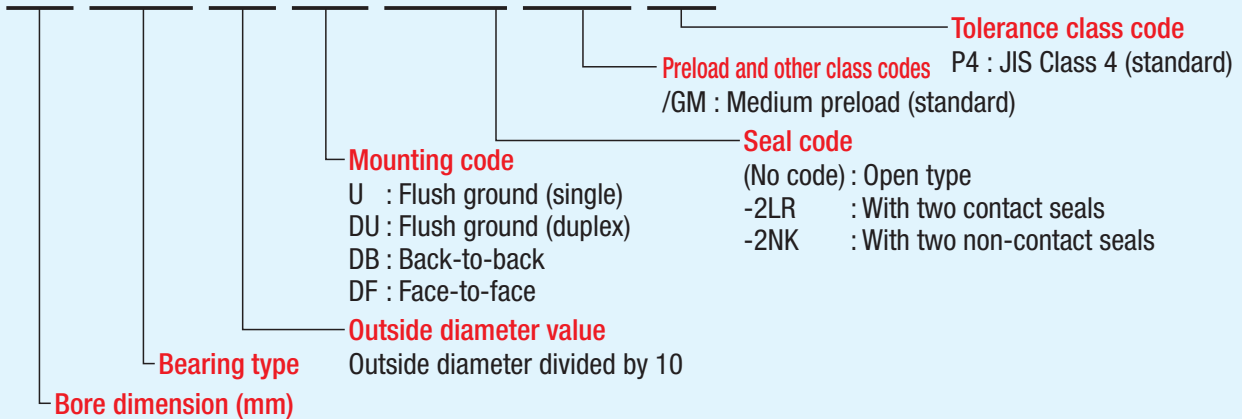

Features

- Resin cage and more balls than previous ball bearings for greater rigidity.
- Combination bearings are provided with preset preloads, eliminating the need for troublesome installation adjustment using shims and torque measurements.
- A contact angle of 60° and has the ability to handle radial and axial loads creates a compact bearing.
- The seal type provides a choice between contact seal and non-contact seal to suit specific applications.

Contact Angle

The contact angle is 60°.

Cage

A ball guided polyamide resin cage is provided as standard.

Accuracy

JIS Class 4 is standard. See page 10 for details.

Preload

Medium preload as standard. See page 20 for details.

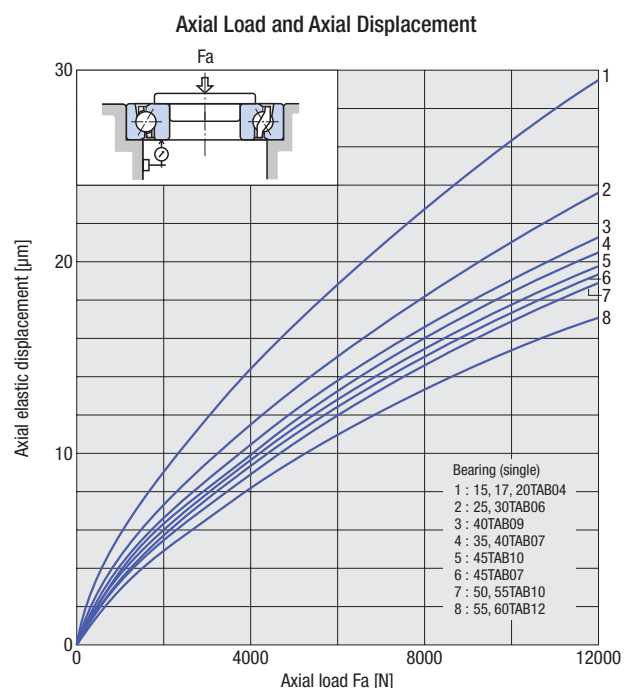

TAF Series

Though hydraulic actuators were widely used in the past in high load drive devices like injection molding machines, the use of electric drives (ball screw drives) in such applications is becoming more common. The TAF Series are special bearings designed to support high-load drive ball screws.

Nomenclature of Bearing Numbers

25 TAF 06 DF /GM P5

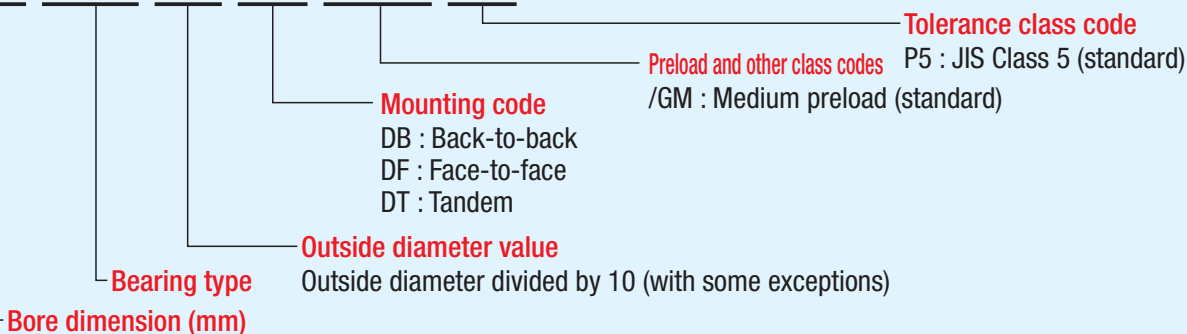

Features

- A large-diameter ball and large contact angle provides the high thrust load capacity needed for the high loads of the ball screw used in injection molding machines.
- A one-piece molded cage that combines both greater accuracy and strength, and the ability to withstand repeated high-speed switching between forward and reverse.

Contact Angle

A contact angle of 50° up to a nominal bore of 80 mm, and 55° for a nominal bore of 100 mm or greater.

Accuracy

JIS Class 5 is standard. See page 11 for details.

Preload

Medium preload as standard. See page 20 for details.

Cage

A ball guide polyamide resin cage is provided as standard. Some sizes come with a machined brass cage.

Comparison of Basic Dynamic Axial Loads

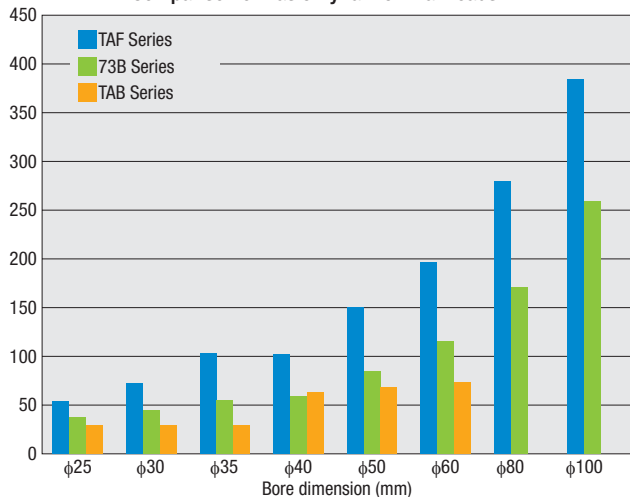

Comparison of Axial Limiting Loads

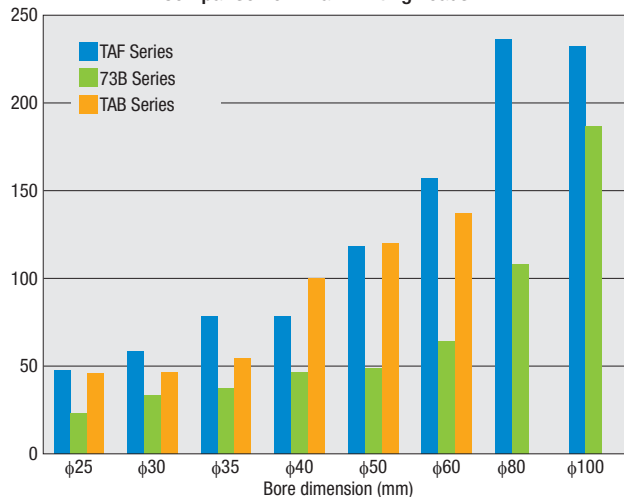

Ball Screw Support Bearing TAB Series

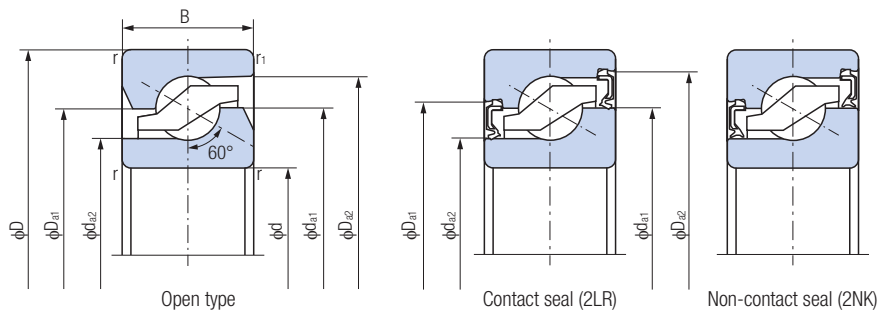

Bearing no.	Boundary dimensions (mm)					Basic dynamic load rating ⁽²⁾ Ca (kN)	Axial limiting load ⁽³⁾ (kN)
	d	D	B	r (Min)	r1 (Min)		
15TAB04	15	47	15	1 ⁽¹⁾	0.6	25.9	32.0
15TAB04-2NK	15	47	15	1 ⁽¹⁾	0.6	25.9	32.0
15TAB04-2LR	15	47	15	1 ⁽¹⁾	0.6	25.9	32.0
17TAB04	17	47	15	1	0.6	25.9	32.0
17TAB04-2NK	17	47	15	1	0.6	25.9	32.0
17TAB04-2LR	17	47	15	1	0.6	25.9	32.0
20TAB04	20	47	15	1	0.6	25.9	32.0
20TAB04-2NK	20	47	15	1	0.6	25.9	32.0
20TAB04-2LR	20	47	15	1	0.6	25.9	32.0
25TAB06	25	62	15	1	0.6	29.9	46.4
25TAB06-2NK	25	62	15	1	0.6	29.9	46.4
25TAB06-2LR	25	62	15	1	0.6	29.9	46.4
30TAB06	30	62	15	1	0.6	29.9	46.4
30TAB06-2NK	30	62	15	1	0.6	29.9	46.4
30TAB06-2LR	30	62	15	1	0.6	29.9	46.4
35TAB07	35	72	15	1	0.6	32.5	54.3
35TAB07-2NK	35	72	15	1	0.6	32.5	54.3
35TAB07-2LR	35	72	15	1	0.6	32.5	54.3
40TAB07	40	72	15	1	0.6	32.5	54.3
40TAB07-2NK	40	72	15	1	0.6	32.5	54.3
40TAB07-2LR	40	72	15	1	0.6	32.5	54.3
40TAB09	40	90	20	1	0.6	65.0	101
40TAB09-2NK	40	90	20	1	0.6	65.0	101
40TAB09-2LR	40	90	20	1	0.6	65.0	101
45TAB07	45	75	15	1	0.6	33.5	59.5
45TAB10	45	100	20	1	0.6	68.0	113
50TAB10	50	100	20	1	0.6	69.5	119
55TAB10	55	100	20	1	0.6	69.5	119
55TAB12	55	120	20	1	0.6	73.0	137
60TAB12	60	120	20	1	0.6	73.0	137

Note (1) Minimum r for inner ring bore is 0.6.

(2) When the axial load is on a 2-row or 3-row arrangement, the values in the table should be multiplied by 1.62 and 2.16 respectively.

(3) When the axial load is on a 2-row or 3-row arrangement, the values in the table should be multiplied by 2 and 3 respectively.

(4) Rotation speed limit for medium preload (preload code GM).

Dynamic equivalent axial load $P_a = X F_r + Y F_a$

No. of bearings in set		2		3			4			
Number of rows receiving axial load		1 row	2 rows	1 row	2 rows	3 rows	1 row	2 rows	3 rows	4 rows
$F_a/F_r \leq 2.17$	X	1.90	—	1.43	2.33	—	1.17	2.33	2.53	—
	Y	0.54	—	0.77	0.35	—	0.89	0.35	0.26	—
$F_a/F_r > 2.17$	X	0.92	0.92	0.92	0.92	0.92	0.92	0.92	0.92	0.92
	Y	1	1	1	1	1	1	1	1	1

Rotation speed limit ⁽⁴⁾ (rpm)		Reference dimensions (mm)				Mass (kg) (Reference)	Bearing no.
Grease lubrication	Oil lubrication	da ₁	da ₂	Da ₁	Da ₂		
6300	8000	33.7	26.8	33.5	41	0.14	15TAB04
6300	—	33.7	26.8	35	41.9	0.14	15TAB04-2NK
6300	—	33.7	26.8	35	41.9	0.14	15TAB04-2LR
6300	8000	33.7	26.8	33.5	41	0.13	17TAB04
6300	—	33.7	26.8	35	41.9	0.13	17TAB04-2NK
6300	—	33.7	26.8	35	41.9	0.13	17TAB04-2LR
6300	8000	33.7	26.8	33.5	41	0.12	20TAB04
6300	—	33.7	26.8	35	41.9	0.12	20TAB04-2NK
6300	—	33.7	26.8	35	41.9	0.12	20TAB04-2LR
4650	6000	46.2	39.7	46	53.4	0.24	25TAB06
4650	—	46.2	39.7	47.5	54.9	0.24	25TAB06-2NK
4650	—	46.2	39.7	47.5	54.9	0.24	25TAB06-2LR
4650	6000	46.2	39.7	46	53.4	0.21	30TAB06
4650	—	46.2	39.7	47.5	54.9	0.21	30TAB06-2NK
4650	—	46.2	39.7	47.5	54.9	0.21	30TAB06-2LR
3750	5000	56.2	49.7	56	63.4	0.29	35TAB07
3750	—	56.2	49.7	57.5	64.9	0.29	35TAB07-2NK
3750	—	56.2	49.7	57.5	64.9	0.29	35TAB07-2LR
3750	5000	56.2	49.7	56	63.4	0.26	40TAB07
3750	—	56.2	49.7	57.5	64.9	0.26	40TAB07-2NK
3750	—	56.2	49.7	57.5	64.9	0.26	40TAB07-2LR
3150	4000	67.2	57.2	67	78.4	0.62	40TAB09
3150	—	67.2	57.2	68.5	79.9	0.62	40TAB09-2NK
3150	—	67.2	57.2	68.5	79.9	0.62	40TAB09-2LR
3400	4500	61.7	55.2	61.5	68.9	0.25	45TAB07
2850	3500	74.2	64.2	74	85.4	0.79	45TAB10
2700	3500	78.2	68.2	78	89.4	0.72	50TAB10
2700	3500	78.2	68.2	78	89.4	0.95	55TAB10
2300	3000	92.2	82.2	92	103.4	1.15	55TAB12
2300	3000	92.2	82.2	92	103.4	1.08	60TAB12

Ball Screw Support Bearing TAF Series

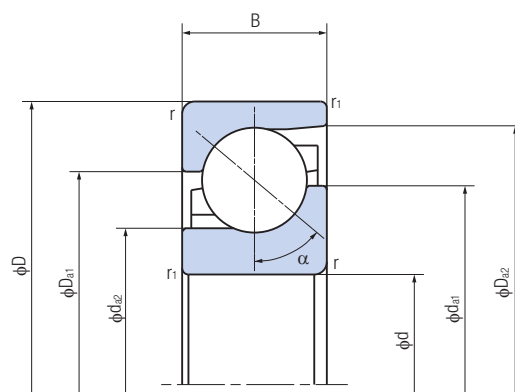

Bearing no.	Boundary dimensions (mm)					Contact angle α (°)	Basic dynamic load rating ⁽¹⁾ Ca (kN)	Axial limiting load ⁽²⁾ (kN)
	d	D	B	r (Min)	r1 (Min)			
25TAF06	25	62	17	1.1	0.6	50	56.0	47.5
30TAF07	30	72	19	1.1	0.6	50	74.0	58.0
35TAF09	35	90	23	1.5	1	50	103	77.0
40TAF09	40	90	23	1.5	1	50	103	77.0
40TAF11	40	110	27	2	1	50	152	118
45TAF11	45	110	27	2	1	50	152	118
50TAF11	50	110	27	2	1	50	152	118
60TAF13	60	130	31	2.1	1.1	50	196	157
60TAF17	60	170	39	2.1	1.1	50	279	238
80TAF17	80	170	39	2.1	1.1	50	279	238
100TAF21	100	215	47	3	1.1	55	385	234
120TAF03	120	260	55	3	1.1	55	445	380

Note (1) When the axial load is on a 2-row or 3-row arrangement, the values in the table should be multiplied by 1.62 and 2.16 respectively.
 (2) When the axial load is on a 2-row or 3-row arrangement, the values in the table should be multiplied by 2 and 3 respectively.
 (3) Use at 80% or less of the allowable axial load is recommended.
 (4) Rotation speed limit for medium preload (preload code GM).

Dynamic equivalent axial load $P_a = X F_r + Y F_a$

Contact angle 50°

No. of bearings in set		2	
Number of rows receiving axial load		1 row	2 rows
Fa/Fr ≤ 1.49	X	1.37	—
	Y	0.57	—
Fa/Fr > 1.49	X	0.73	0.73
	Y	1	1

Contact angle 55°

No. of bearings in set		2	
Number of rows receiving axial load		1 row	2 rows
Fa/Fr ≤ 1.79	X	1.60	—
	Y	0.56	—
Fa/Fr > 1.79	X	0.81	0.81
	Y	1	1

Rotation speed limit ⁽⁴⁾ (rpm) Grease lubrication	Reference dimensions (mm)				Mass (kg) (Reference)	Bearing no.
	da1	da2	Da1	Da2		
4500	42.9	32.7	44.9	56.6	0.237	25TAF06
3800	49.8	38.6	53	65.9	0.357	30TAF07
3000	63.2	49.7	67.7	82.3	0.709	35TAF09
3000	63.2	49.7	67.7	82.3	0.655	40TAF09
2500	77.6	60.3	83.4	101.1	1.28	40TAF11
2500	77.6	60.3	83.4	101.1	1.21	45TAF11
2500	77.6	60.3	83.4	101.1	1.13	50TAF11
2100	92.4	72.9	98.9	119.7	1.79	60TAF13
1500	121.1	97.2	130.3	155.8	4.48	60TAF17
1500	121.1	97.2	130.3	155.8	3.80	80TAF17
1200	152.3	123.4	164.1	194.7	7.41	100TAF21
1000	186.2	151.1	193.8	228.4	14.8	120TAF03

Dimension Tables

Types and Designs

7900
7000
7200

BNH

TAH
TBH

NN3000
NNU4900

XRN
XRG

TAB
TAF

NACHI-FUJIKOSHI CORP.

URL: <http://www.nachi-fujikoshi.co.jp>
E-mail: webmaster@nachi-fujikoshi.co.jp

Tokyo Head Office : Shiodome Sumitomo Bldg. 17F 1-9-2 Higashi-shinbashi, Minato-ku, Tokyo 105-0021, JAPAN
Tel: +81-(0)3-5568-5111 Fax: +81-(0)3-5568-5206

Toyama Head Office : 1-1-1 Fujikoshi-Honmachi, Toyama 930-8511, JAPAN Tel: +81-(0)76-423-5111 Fax: +81-(0)76-493-5211

Overseas Companies

AMERICA

Sales

● **NACHI AMERICA INC. HEADQUARTERS**
715 Pushville Road, Greenwood, Indiana, 46143, U.S.A.
Tel: +1-317-530-1002 Fax: +1-317-530-1012
URL: <http://www.nachiamerica.com/>

WEST COAST BRANCH
12652 E. Alondra Blvd. Cerritos, California, 90703, U.S.A.
Tel: +1-562-802-0055 Fax: +1-562-802-2455

MIAMI BRANCH - LATIN AMERICA DIV.
2315 N.W. 107th Ave., Doral, Florida, 33172, U.S.A.
Tel: +1-305-591-0054/0059/2604
Fax: +1-305-591-3110

● **NACHI ROBOTIC SYSTEMS INC.**
22285 Roethel Drive, Novi, Michigan, 48375, U.S.A.
Tel: +1-248-305-6545 Fax: +1-248-305-6542
URL: <http://www.nachirobotics.com/>

● **NACHI CANADA INC.**
89 Courtland Ave., Unit 2, Concord, Ontario, L4K 3T4, CANADA
Tel: +1-905-660-0088 Fax: +1-905-660-1146
URL: <http://www.nachicanada.com/>

● **NACHI MEXICANA, S.A. DE C.V.**
Urbina No. 54, Parque Industrial Naucalpan, Naucalpan de Juarez, Estado de Mexico, C.P. 53370, MEXICO
Tel: +52-55-3604-0832 / 0842 / 0881
Fax: +52-55-3604-0882

NACHI MEXICANA ENGINEERING CENTER
1171A, Calle Julio Diaz Torre, Frace, Ciudad Industrial, Aguascalientes, C.P. 20290, MEXICO
Tel: +52-449-971-1689 Fax: +52-449-971-1689

Manufacturing

● **NACHI TECHNOLOGY INC.**
713 Pushville Road, Greenwood, Indiana, 46143, U.S.A.
Tel: +1-317-535-5000 Fax: +1-317-535-8484
URL: <http://nachitech.com/>

● **NACHI TOOL AMERICA INC.**
717 Pushville Road, Greenwood, Indiana, 46143, U.S.A.
Tel: +1-317-535-0320 Fax: +1-317-535-0983

● **NACHI BRASIL LTDA.**
Avenida João XXIII, No.2330, Jardim São Pedro, Mogi das Cruzes, S.P., BRASIL, CEP 08830-000
Tel: +55-11-4793-8800 Fax: +55-11-4793-8870
URL: <http://www.nachi.com.br/>

SAO PAULO BRANCH
Av. Paulista, 453, Primeiro Andar, Conj.11, 12, 12 e 14, Cerqueira Cesar, Sao Paulo - SP, CEP: 01311-000, BRASIL
Tel: +55-11-3284-9844 Fax: +55-11-3284-1751

EUROPE

Sales

● **NACHI EUROPE GmbH**
Bischofstrasse 99, 47809, Krefeld, GERMANY
Tel: +49-(0)2151-65046-0
Fax: +49-(0)2151-65046-90
URL: <http://www.nachi.de/>

SOUTH GERMANY OFFICE
Pleidelsheimer Strasse 47, 74321, Bietigheim-Bissingen
Tel: +49-(0)7142-77418-0
Fax: +49-(0)7142-77418-20

SPAIN BRANCH
P.I. EL MONTALVO III C/Segunda, 6. Portal 1-2ª, Oficina 5 37188-Carbajosa de La Sagrada Salamanca- España
Tel: +34-(0)923-197-837
Fax: +34-(0)923-197-758

CZECH BRANCH
Sezemicka 2757/2, Praha 9 193 00, Horni Pocernece VGP Park - Building A1, CZECH
Tel: +420-255-734-000 Fax: +420-255-734-001

U.K. BRANCH

Unit 3, 92, Kettles Wood Drive Woodgate Business Park, BIRMINGHAM B32 3DB, U.K.
Tel: +44-(0)121-423-5000
Fax: +44-(0)121-421-7520

TURKEY BRANCH

Karaman Ciftligi Mevki, Agaoglu My Prestige, K:13, D:110, 34746, Atasehir, Istanbul, TURKEY
Tel: +90-(0)216-688-4457 Fax: +90-(0)216-688-4458

Manufacturing

● **NACHI CZECH s.r.o**
Prumyslova 2732, 440 01 Louny, CZECH
Tel: +420-415-930-930 Fax: +420-415-930-940

ASIA and OCEANIA

Sales

● **NACHI SINGAPORE PTE. LTD.**
No.2 Joo Koon Way, Jurong Town, Singapore 628943, SINGAPORE
Tel: +65-65587393 Fax: +65-65587371

VIETNAM REPRESENTATIVE OFFICE, HO CHI MINH
4Fl., Yoco Bld., 41 Nguyen Thi Minh Khai St., Dist.1, Ho Chi Minh, VIETNAM
Tel: +84-8-3822-3919 Fax: +84-8-3822-3918

VIETNAM REPRESENTATIVE OFFICE, HANOI
5B Fl., Noza Bld., 243 Cau Giay St., Cau Giay Dist., Hanoi, VIETNAM
Tel: +84-4-3767-8605 Fax: +84-4-3767-8604

● **FUJIKOSHI-NACHI (MALAYSIA) SDN. BHD.**
No.17, Jalan USJ 21/3, 47630 UEP Subang Jaya, Selangor Darul Ehsan, MALAYSIA
Tel: +60-(0)3-80247900 Fax: +60-(0)3-80235884

● **PT.NACHI INDONESIA**
Jl.H.R.Rasuna Said Kav.X-O Kuningan, Jakarta 12950, INDONESIA
Tel: +62-021-527-2841 Fax: +62-021-527-3029

● **NACHI KG TECHNOLOGY INDIA PVT. GURGAON HEAD OFFICE**
Unit No.207, Sewa Corporate Park, MG Road, Iffco Chowk, Gurgaon-122001, INDIA
Tel: +91-124-450-2900 Fax: +91-124-450-2910

BANGALORE OFFICE
F-11 Asha Chamber, No2, Venkata Swami Raju Road, Kumara Park West, Bangaore-560020, INDIA

● **那智不二越(上海)贸易有限公司 NACHI (SHANGHAI) CO.,LTD.**
11F Royal Wealth Center, No.7 Lane 98 Danba Road, Putuo District, Shanghai, 200062, CHINA
Tel: +86-(0)21-6915-2200
Fax: +86-(0)21-6915-5427

重庆分公司 CHONGQING BRANCH
Room 17-18/17-19, Tower C, Hongding Guoji Mingyuan, Jiangbei District, Chongqing 400020, CHINA
Tel: +86-(0)23-8816-1967
Fax: +86-(0)23-8816-1968

沈阳分公司 SHENYANG BRANCH
Room 304, No.1 Yuebin Street, Shenhe District, Shenyang 110000, CHINA
Tel: +86-(0)24-3120-2252
Fax: +86-(0)24-2250-5316

北京分公司 BEIJING BRANCH
Room 1110, Kuntai International Mansion, Building O, Yi No.12 Chao Wai Street, Chao yang District, Beijing 100020, CHINA
Tel: +86-(0)10-5879-0181
Fax: +86-(0)10-5879-0182

● **NACHI-FUJIKOSHI CORP. TAIPEI REPRESENTATIVE OFFICE**
No.109, Kao Young North Rd, Lung-Tan Hsin, Tao-Yuan Hsien, TAIWAN
Tel: +886-(0)3-411-7776
Fax: +886-(0)3-471-8402

● **NACHI-FUJIKOSHI CORP. KOREA REPRESENTATIVE OFFICE**
3F A-Youn Digital Tower 314-37, Seongsu-dong 2-ga, Seongdong-gu, Seoul 133-120, KOREA
Tel: +82-(0)2-469-2254 Fax: +82-(0)2-469-2264

● **NACHI (AUSTRALIA) PTY. LTD.**
Unit 1, 23-29 South Street, Rydalmere, N.S.W, 2116, AUSTRALIA
Tel: +61-(0)2-9898-1511 Fax: +61-(0)2-9898-1678
URL: <http://www.nachi.com.au/>

Manufacturing

● **NACHI TECHNOLOGY (THAILAND) CO., LTD.**
5/5 M, 2, Rojana Industrial Estate Nongbua, Ban Khai, Rayong, 21120, THAILAND
Tel: +66-38-961-682 Fax: +66-38-961-683

BANGKOK SALES OFFICE
Unit 23/109(A), Fl.24th Sorachai Bldg., 23 Sukhumvit 63 Road(Ekamai), Klongtonnua, Wattana, Bangkok 10110, THAILAND
Tel: +66-2-714-0008 Fax: +66-2-714-0740

● **NACHI INDUSTRIES PTE. LTD.**
No.2 Joo Koon Way, Jurong Town, Singapore 628943, SINGAPORE
Tel: +65-68613944 Fax: +65-68611153
URL: <http://www.nachinip.com.sg/>

● **NACHI PILIPINAS INDUSTRIES, INC.**
1st Avenue, Manalac Compound, Sta. Maria Industrial Estate, Bagumbayan, Taguig, Metro Manila, PHILIPPINES
Tel: +63-(0)2-838-3620 Fax: +63-(0)2-838-3623

● **NACHI KG TECHNOLOGY INDIA PVT. NEEMRANA PLANT**
Plot No. SP2-86, RIICO Industrial Area, Neemrana 301705, Distt. Alwar, Rajasthan, INDIA

● **NACHI MOTHERSON PRECISION LTD.**
179, Sector4, JMT Manesar, District Gurgaon-122050, Haryana, INDIA
Tel: +91-124-4936-000 Fax: +91-124-4936-022

● **NACHI MOTHERSON TOOL TECHNOLOGY LTD.**
D-59-60, Sector-6, Noida-201301, Distt. Gautam Budh Nagar, U.P. INDIA
Tel: +91-120-425-8372 Fax: +91-120-425-8374

● **那智不二越(江苏)精密机械有限公司 NACHI (JIANGSU) INDUSTRIES CO., LTD.**
39 Nanyuan Road, Economic and Technological Development Zone (south), Zhangjiagang, Jiangsu, 215618, CHINA
Tel: +86-(0)512-3500-7616
Fax: +86-(0)512-3500-7615

● **东莞建越精密轴承有限公司 DONGGUAN NACHI C.Y. CORPORATION**
Dangyong Village, Hongmei Town Dongguan City, Guangdong, CHINA
Tel: +86-(0)769-8843-1300
Fax: +86-(0)769-8843-1330

● **上海不二越精密轴承有限公司 SHANGHAI NACHI BEARINGS CO.,LTD.**
Yitong Industry Zone 258, Fengmao Rd. Malu Town, Jiading, Shanghai 201801, CHINA
Tel: +86-(0)21-6915-6200 Fax: +86-(0)21-6915-6202

● **建越工業股份有限公司 NACHI C.Y. CORP.**
No.109, Kao Young North Rd, Lung-Tan Hsin, Tao-Yuan Hsien, TAIWAN
Tel: +886-(0)3-471-7651 Fax: +886-(0)3-471-8402

NACHI

The appearance and specifications may be changed without prior notice if required to improve performance.

Every care has been taken to ensure the accuracy of the information contained in this catalog but no liability can be accepted for any errors or omissions.



CATALOG NO.	B1031E-5
--------------------	-----------------

2013.05.X-ABE-ABE